



Laser Autocollimator

Smart LAC H420 Series

User's Manual

Thank you for purchasing our product.

Before using the products, read this manual, thoroughly.

After reading this manual, store it for your future immediate referencing.

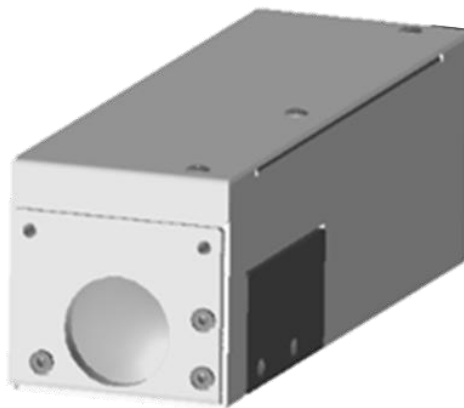

Table of Contents

Preface.....	8
0. Definitions (terms and abbreviations)	9
1. For your Safety – Precautions of Use	10
1.1 Warning labels addressed in this Manual.....	10
1.2 Managing this Product.....	10
1.3 Precautions.....	11
1.3.2 Power Supply	11
1.3.3 Disassembly/Modification.....	11
1.3.4 Effects of dust and dirt	11
1.3.5 Influence of Vibration	12
1.3.6 Disturbance by the air fluctuation	12
1.3.7 Waterproof and Explosionproof	12
1.3.8 Actions in case of abnormality.....	12
1.3.9 Repair.....	13
1.3.10 Disposal of this Product	13

1.3.11 Residual Risks.....	13
1.4 Use of laser products for your safety.....	14
1.4.1. Corresponding laser classes for Autocollimater H420 series	14
1.4.2. Laser Class Identification Labels on the Products	15
1.4.3. Common locations for the laser labels to all models.....	16
2. Preparations.....	17
2.1 Functions and Features	17
2.2 Checking the Packaging	19
2.3 Overview of H420 Series Specifications	19
2.4 H420 Series External Dimensions	20
2.5 Names for the Sensor Head Parts and their functions.....	22
2.6 System Configuration Example.....	23
2.7 Required Parts for Configuration	23
2.8 H420 Installation Method (Example).....	24
I. Fix the H420 and an adapter plate (sold separately) for the HB10 with hex socket head cap bolts (model: CBM4x8).....	24
II. Fix the HB10 and H12 with hex socket head cap bolts in the 4 locations.	24
III. Fasten the HB10.	24
2.9 Connecting the power to the Internal Light Source	25
2.10 Connection to a Computer	25
2.11 Software - Installation of Suruga OptGauge.....	26

2.11.1 Software License	26
2.11.2 Recommended operating system environment for installation.....	27
2.11.3 Installation of Suruga OptGauge	28
2.12 Turning the Power On.....	34
3. Settings	35
3.1 Sensor Head Usage Precautions and Setting (Installation) by Model.....	35
3.1.1 Mounting (with HB10).....	35
3.1.2 For reflection angle measurement	36
3.1.3 For external light angle measurement	37
3.2 Names and Functions in the OptGauge Software Main Screen.....	39
3.2.1 OptGauge Main Screen Details.....	40
3.3 Function Details (and Parameter Detail Settings).....	43
3.3.1 Tilt Angle/Beam Angle	43
3.3.2 Divergence.....	44
3.3.3 Beam Centroid.....	45
3.3.4 Beam Ellipticity.....	47
3.3.5 Judgement.....	49
3.3.6 Adaptive Cal	53
3.3.7 Aperture	55

3.3.8	Origin Offset.....	57
3.3.9	Zoom In	58
3.3.10	Multi Spot.....	60
3.4	Names and Functions of Option Screen Components.....	63
3.4.1	Measurement Option Setting Details.....	64
3.5	Option List.....	70
3.5.1	Switching Option Lists.....	70
3.5.2	Registering Option Lists	71
3.5.3	Deleting Option Lists.....	72
4.	Measuring	73
4.1.	Overview of Measurement Methods	73
4.1.1.	Angle measurement using the reflection angle measurement	73
4.1.2.	Angle measurement using the external light angle measurement.....	73
4.1.3.	Beam divergence measurement	73
4.1.4.	Multi Spot measurement.....	73

5.	Controlling from External Devices	74
5.1.	RS232C.....	74
5.1.1.	Communication Specifications	74
5.1.2.	The Connections Illustrated	75
5.1.3.	Command Communication Setting Method	76
5.2.	TCP/IP	77
5.2.1.	Communication Specifications	77
5.2.2.	Image of Connection.....	78
5.2.3.	Command Communication Setting Method	80
5.3.	List of Commands.....	84
5.3.1.	List of Read Commands.....	84
5.3.2.	List of Write Commands.....	87
5.3.3.	List of Execute Commands	89
5.4.	Read Commands.....	89
5.4.1.	Command Format.....	89
5.5.	Write Commands	100
5.5.1.	Command Format.....	100
5.6.	Execute Commands.....	110
5.6.1.	Command Format.....	110
5.7.	Communication error	110
6.	System Log	111
6.1.	System Log List	111
6.2.	Error Messages and Countermeasures	112

7.	Specifications for H420 Series Sensor Head and Accessories	113
7.1.	Sensor Head Specifications.....	113
7.2.	AC/DC Converter Electrical Specifications	114
7.3.	Sensor Head and Cable Electrical Specifications	114
8.	Failures? Frequently Asked Questions	115
9	Warranty - After-Sales Service	116
9.1	Warranty Terms, Conditions and Coverage.....	116
9.2	After-Sales Service.....	116

Preface

This document is the "User's Manual" for the H420 series - Laser Autocollimator (hereafter, referred to as "the Products" or "the sensor head").

This "User's Manual" (hereafter referred to as "this Manual") provides information and basic operating instructions for the Products.

To use the Products effectively and safely, please read this Manual carefully and fully understand its contents before using the Products.

【COPYRIGHT】

Copyright © SURUGA SEIKI Co. Ltd. All rights reserved.

H420 Series User's Manual

Issue Date	2023 March
Manual Version	V.1.1.0

Revision History

Date	Revision	Details
2024 Jan	V.1.0.0	1 st version
2024 March	V.1.1.0	Suruga OptGuage Ver.1.1.0

NOTICE

The information contained in this Manual is deemed correct at the time of publication.

SURUGA SEIKI CORPORATION reserves the right to change specifications without notice to the user of the Product offered.

The latest version of this Manual can be downloaded from our WEB site

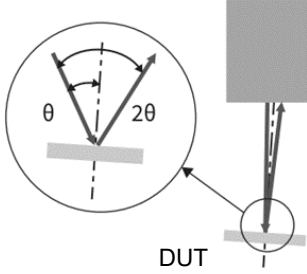
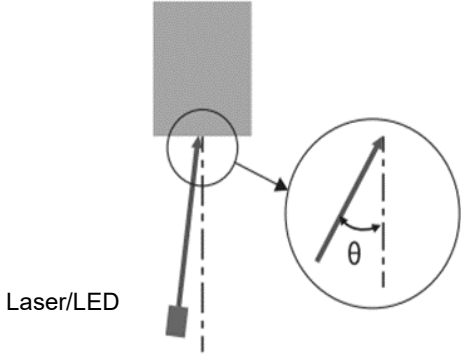

(<http://jpn.surugaseiki.com/>).

0. Definitions (terms and abbreviations)

Terms and Abbreviations	Definitions
<p>Reflection Angle Measurement</p>	 <p>The diagram shows a Device Under Test (DUT) represented by a horizontal grey bar. A light source, shown as a grey rectangle above the DUT, emits a beam that reflects off the top surface of the DUT. A circular inset provides a magnified view of the reflection point. In this inset, a vertical dashed line represents the normal to the surface. The angle between the incident beam and the normal is labeled θ. The angle between the reflected beam and the normal is labeled 2θ.</p> <p>A method to measure the angle of a beam from internal light source reflected up on a device under test (DUT). The angle 2θ is measured to calculate the θ as result.</p>
<p>External Light Angle Measurement</p>	 <p>The diagram shows a grey rectangle representing a light source labeled "Laser/LED" positioned below a horizontal grey bar representing the device. A beam of light is directed upwards from the source towards the device. A circular inset shows a magnified view of the beam's path, where the angle between the beam and a vertical dashed line is labeled θ.</p> <p>A method to measure the angle θ of a beam from external light source such as laser or LED.</p>

1. For your Safety – Precautions of Use

1.1 Warning labels addressed in this Manual

 Danger	May result in serious physical disability or death.
 Warning	May result in severe injury, damage to equipment, or other severe damage.
 Careful	May result in minor physical injury or equipment damage.
Attention	Instructions for safe handling are provided for the product.

1.2 Managing this Product

- The Products uses a laser diode for its internal light source. We recommend that the products are in an environment where appropriate safety measures are taken for the laser class before any use.
- We do not guarantee the functions and performance of the Products if used in a manner other than that specified in this Manual, or if being modified.
- When other equipment combines the Products, the functions and Suruga shall not guarantee the performance of the Products, depending on your design, operating conditions, and environment.
- Do not subject each device, including peripherals, to sudden temperature changes. Doing so may cause condensation and equipment failure.
- Do not wipe the product with a wet rag, benzene, thinner, or the alike. Doing so may cause discoloration or deformation of the Product. If the Product is heavily soiled, wring out a cloth with diluted PH-neutral detergent and wipe off the stain, then dry the Product with a soft cloth.
- If you suspect the Product being malfunctioning, please contact our local sales office.

1.3 Precautions

1.3.1 Ambient Temperature and Illuminance

- Changes in ambient temperature can cause measurement errors. Please be advised to keep the ambient temperature, always, at a constant level.
- Avoid using the Products near lighting equipment that repeatedly turns on and off at high frequencies. If this is not possible, use a light shield or similar device to avoid being affected.

1.3.2 Power Supply



- Use the correct power supply voltage. Failure to do so may result in fire, electric shock, or malfunction.
- Be sure to turn off the power to the Product and devices connected to the Product when connecting or disconnecting various connecting wires. Failure to do so may result in damage to the Product.
- Do not turn off the power while setting items. Sudden power cut-off while setting data, part or all configuration data may be lost.

1.3.3 Disassembly/Modification



Do not disassemble or modify the unit. Doing so may cause fire or electric shock. The warranty is void if the Product is disassembled or modified by anyone other than our employees or our certified third party.

1.3.4 Effects of dust and dirt

The following cases may cause measurement errors due to the influence of dust, dirt, water, oil, etc.

- Dust and dirt on the cover glass: Use dry-clean air to blow off any dirt on the cover glass. If the cover glass is heavily soiled, wipe it off with a soft cloth soaked in thin alcohol.
- Adhesion on the surface of the object to be measured: Blow it off with clean air or wipe off the dirt.
- Intrusion into the optical axis area by floating or by splashing: Take measures such as installing a protective cover or air purging.

1.3.5 Influence of Vibration

- Vibration to a DUT may cause the measured value to vary. In such a case, a more accurate measurement can be obtained by increasing the number of times the measured values are averaged.

1.3.6 Disturbance by the air fluctuation

The influence of slow air fluctuation may cause the measured value to vary. In such cases, covering the measuring section with an airproof cover is an effective countermeasure.

1.3.7 Waterproof and Explosionproof



The Products are not intended for use in areas where explosion protection is required. Do not use the Products in locations where flammable gases or other explosive atmospheres exist.

The Products are not waterproof. Do not use the Products in locations where liquids may splash or flow into the Products.

1.3.8 Actions in case of abnormality



In the following cases, turn the power OFF, immediately. Use of the Product under abnormal conditions may result in malfunction.

- When abnormal sounds, strange smells, or smoke is detected.

- If the power cord is damaged.
- If water or other liquid is spilled on the Product.

1.3.9 Repair

For repair, please contact our local sales office.

- When water or foreign matter gets inside the main unit
- When the product is damaged due to being dropped or external impact.
- When there is a strange odor due to smoke emission

1.3.10 Disposal of this Product

When disposing of the Product, treat it as industrial waste. Please follow in accordance with laws and regulations or by other appropriate methods. We do not collect the Product for purpose.

Please dispose of all materials used to package this product in accordance with the law or by other appropriate methods. We do not collect these materials for the purpose.

1.3.11 Residual Risks

This document does not disclose all risks associated with the Product. For residual or unexpected risks, or any other risks involved, please implement the safety design of machinery in accordance with ISO 12100 or your appropriate industrial safety standards.

1.4 Use of laser products for your safety

1.4.1. Corresponding laser classes for Autocollimater H420 series



The following describes the hazards of the laser classes in the H420 series.

For specific safety precautions for the laser class, please follow your occupational safety regulations.



Table for Laser Class, Precautions, and the Corresponding Products

Laser Class	Precautions
Class 1	<p>Safe under reasonably foreseeable conditions</p> <p>A Laser product which is safe for use with observation optics such as loupes and binoculars</p> <p>The corresponding H420 series Products: All models with a built-in laser at the wavelength of 405 nm</p>
Class 2	<p>Normally, the eyes are protected and safe due to aversion reactions such as blinking.</p> <p>Laser products that may cause temporary visual impairment or risk of secondary injury due to aversive reactions if the user intentionally stares at the laser beam.</p> <p>The corresponding H420 series of products: All models with a built-in laser at the wavelength of 660 nm</p>

Ref : IEC 60825:2014 (JIS C 6802 : 2014) *Safety of Laser Products*

1.4.2. Laser Class Identification Labels on the Products

The following table shows the laser class identification labels for this product and where they are attached.

The label contents differ depending on the product model. Please confirm the model of the product before any use.



Laser C lass Identification Labels

Laser Class 1	Laser Class 2
<div data-bbox="264 745 683 1144" style="border: 2px solid black; padding: 10px; text-align: center;"> <p>クラス1レーザー製品 Class 1 Laser Product (IEC60825-1 : 2014)</p> <hr/> <p>*Output : 0.39mW *Wavelength : 405nm *Duration : CW</p> </div> <p style="text-align: center;">Background Color: Yellow Text Color: Black</p>	<div data-bbox="916 745 1334 1144" style="border: 2px solid black; padding: 10px; text-align: center;"> <p>クラス2レーザー製品 Class 2 Laser Product (IEC60825-1 : 2014)</p> <hr/> <p>*Output : 1mW *Wavelength : 405nm *Duration : CW</p> </div> <p style="text-align: center;">Background Color: Yellow Text Color: Black</p>

Warning Label



Background Color: Yellow
Text Color: Black

Labeling method and contents conform to IEC60825-1:2014 (JIS C 6802:2014)

1.4.3. Common locations for the laser labels to all models

The laser warning label is attached to the top of the Products.

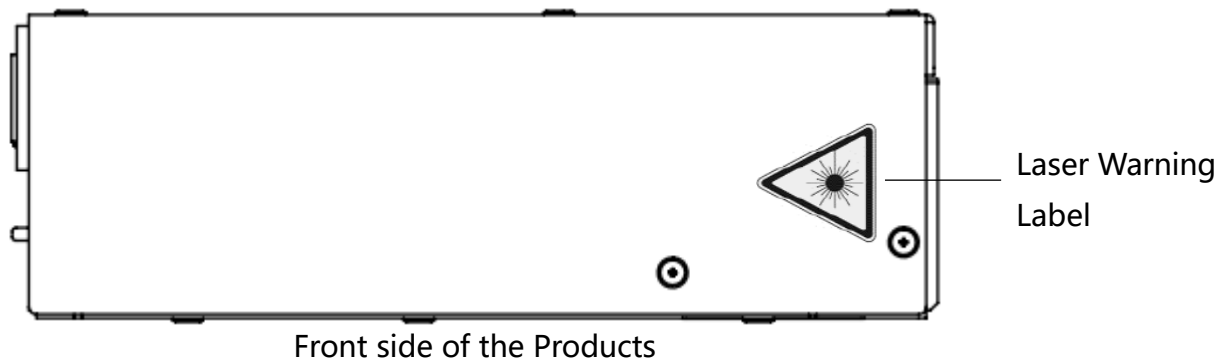

The laser identification label for the specific laser class is attached to the left side of the Products on the laser emission port side.

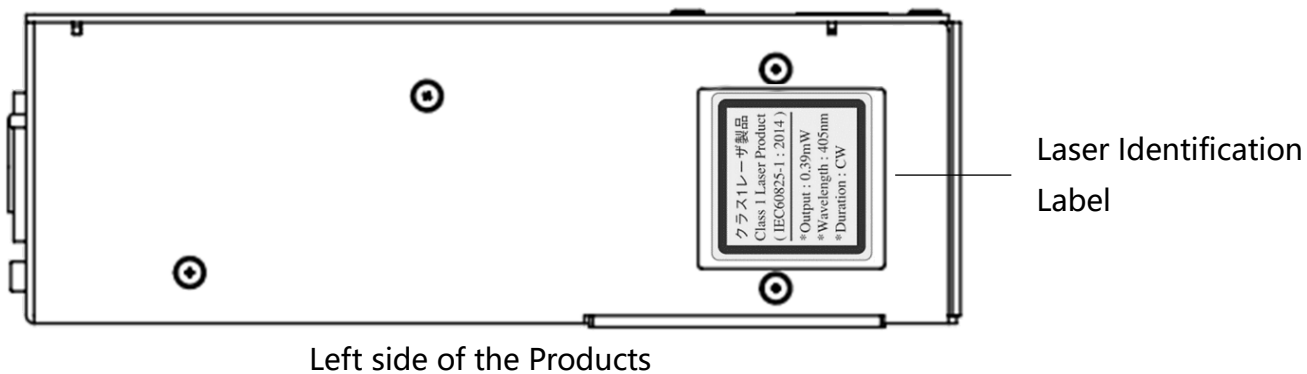

2. Preparations

This chapter describes the Products about the following:

- Functions and Features
- Overview of H420 Series Common Specifications
- H420 Series External Dimensions
- Names and Functions of Sensor Head Parts

2.1 Functions and Features

The Products are autocollimator which derives oblique of a target object from the incident light to the sensor. The following features are available.

- High-accuracy angle measurements
 - Measurement range: $\pm 1.35^\circ$
 - Repeatability: 1s (resulting from 6 sigma at averaging times of 256)
 - Linearity: 0.25% of F.S. (F.S = 2.7 degree at working distance of 100 mm)
*See "Detailed Specifications for H420 Series Sensor Head and Accessories"
- Beam divergence measurement is available.
 - Measurement range: ≤ 20 mrad
 - Linearity: ± 0.25 % of F.S. (F.S. = 20 mrad)
*See "Beam Divergence" in the Function Details.
- The PC application connecting the sensor head cable that reads out results is available.
* See "Preparations - System Configuration Example"
- Measurement of multiple reflection points is available.
* See "Function Details - Multi Spot"
- The reflection angle measurement and the external light angle measurement are available.
 - For reflection angle measurement, use the internal light source to measure the angle of its reflected light.

- For external light angle measurement, directly measure the angle of the beam such as laser or LED.

*See "Tilt Angle/Beam Angle" in the Function Details



List of Functions

Function		Details
Measurement	Angle measurement	See "Tilt Angle/Beam Angle" in the Function.
	Beam divergence measurement	See "Beam Divergence" in the Function.
Convenient Functions	Maximum luminance value measurement	See "Power" in the Suruga OptGauge Main Screen.
	Total count measurement	
	Binning	See "Binding" in the Measurement Option Setting.
	ROI	See "Aperture" in the Function.
	Auto Aperture	
	Adaptive Cal	See "Adaptive Calibration" in the Function.
	Denoising	See "Denoising" in the Measurement Option Setting.
Measurement results storage	See "Log File" in the Measurement Option Setting	
Display	Zero offset	See "Origin Offset" in the Function
	Unit conversion	See "Angle Unit" in the Measurement Option Setting.
	Rotation display	See "Camera Settings" in the Measurement Option Setting.
	Mirroring display	
	Screen image zoom	See "Zoom In Display" in the Function.
Judgement	Angle judgement	See "Judgement" in the Function.
	Beam divergence judgement	

	Maximum luminance value judgement	
Communication	RS232C	See “RS232C” in the Control from External Devices.
	TCP/IP	See “TCP/IP” in the Control from External Devices.

2.2 Checking the Packaging

In addition to the product itself, the package delivered to the customer contains an adjusting screwdriver for the internal light source and a USB memory stick.

1.  A H420 body
2.  A screwdriver for the light intensity adjustment
3.  A USB memory stick (contents: Suruga OptGauge (measurement application), camera driver, device authentication file and this Manual).

*The latest version can be downloaded from the Suruga website (<http://jpn.surugaseiki.com/>).

4. An AC/DC power supply for the Internal light source

2.3 Overview of H420 Series Specifications

H420 Series Common Specifications Table

External dimensions (mm)	120 x 40 x 40
Product weight	400 g
Main power source	12 VDC
Power consumption	5 W or below
Laser class	Class 1 or Class 2 (differs by model)
Protective functions	Short-circuit protection, polarity reversed connection protection
Communication functions	USB3.0 standard
Operating temperature/humidity	5 to 40 °C, 35% to 85% RH (no condensation)
Storing temperature and humidity	-10 to 65 °C and 10% to 85% RH (no condensation)
Atmosphere	Avoid direct sunlight, corrosive or inflammable gases, liquids, powders/dust, and other toxic substances
Housing Material	Aluminum

2.4 H420 Series External Dimensions

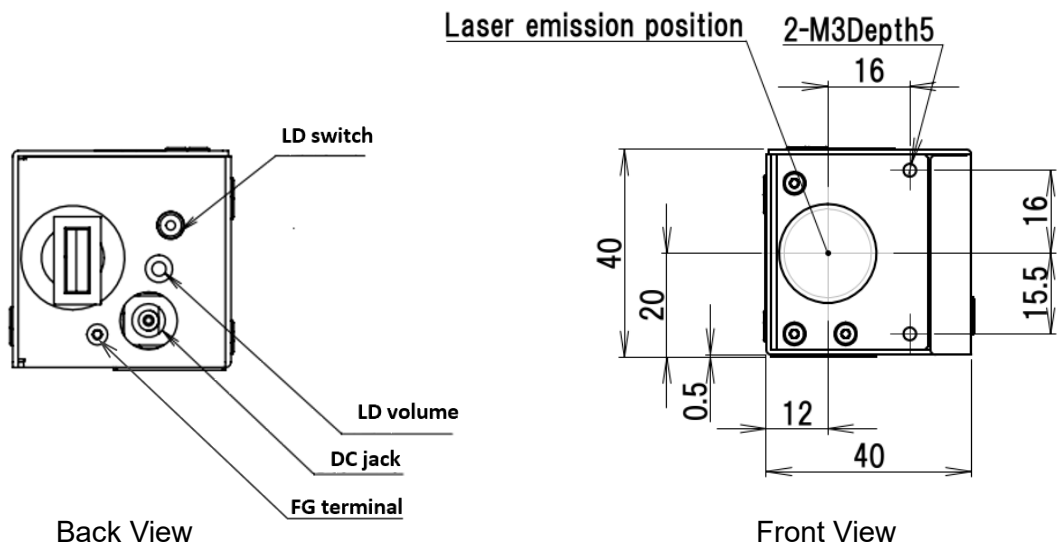
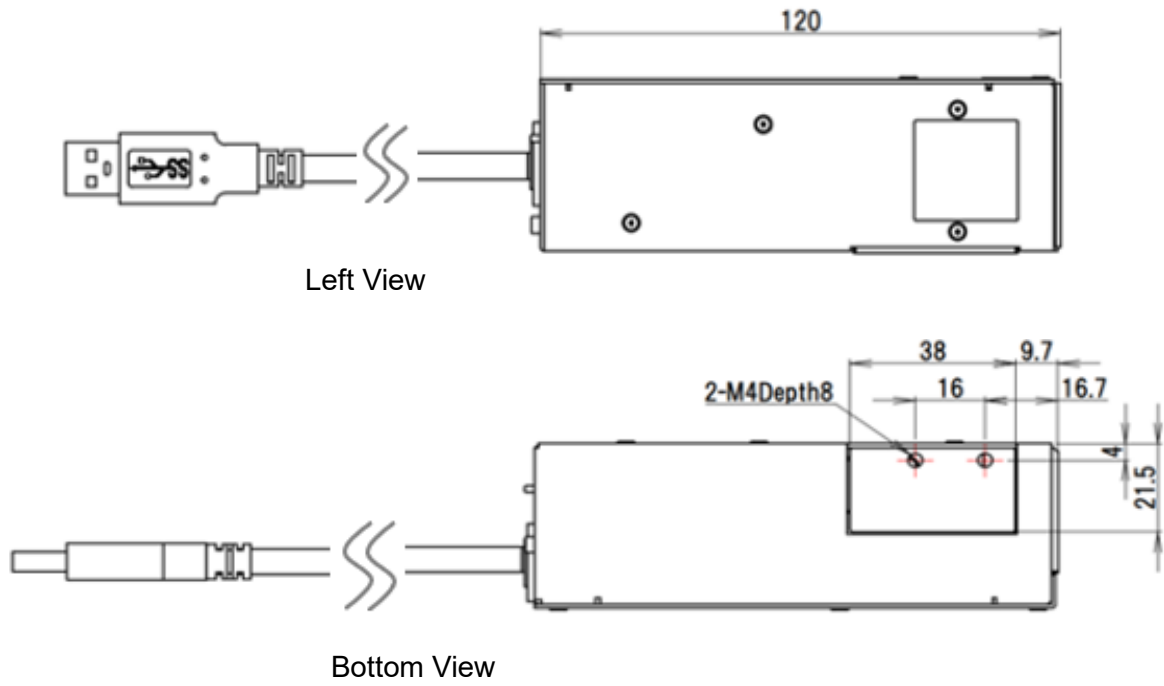

Dimensions for the mount adapter plate for HB10 (model number: H420-AP, sold separately)

*For using the adapter for HB10, see "H420 Installation Method"

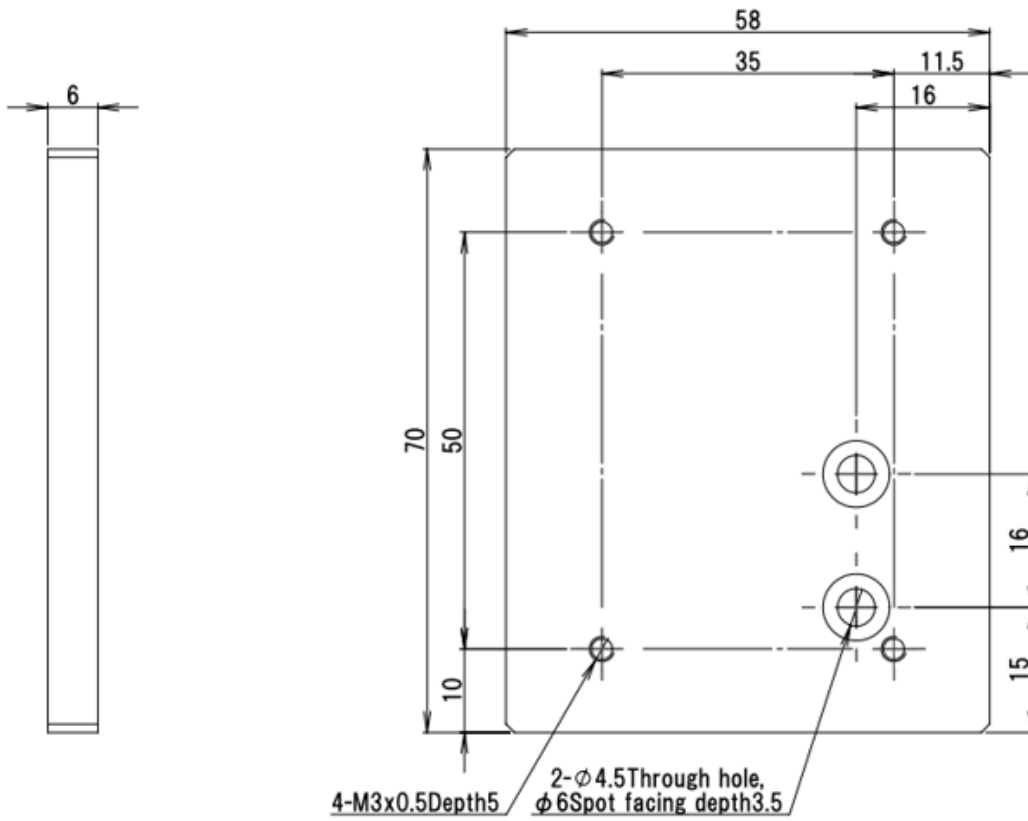

2.5 Names for the Sensor Head Parts and their functions

① Internal light source ON/OFF switch

When turned ON, the switch lights up orange as the internal light source is powered.

② USB connector

It connects H420 to a customer's computer.

③ A knob for Internal light source intensity adjustment

It adjusts the internal light source intensity. Turn clockwise to increase its intensity and counterclockwise to decrease it.

*For the adjustment, use the screwdriver included in accessories.

④ Power inlet for internal light source

A terminal for the AC/DC adapter for the internal light source.

⑤ FG Terminal

A frame ground to reduce electrical noise and to prevent malfunction.

⑥ Laser emission port

Irradiates the laser when the internal light source is ON.

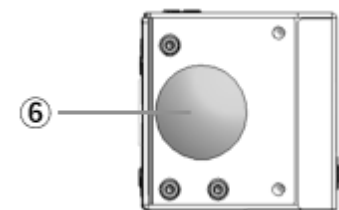
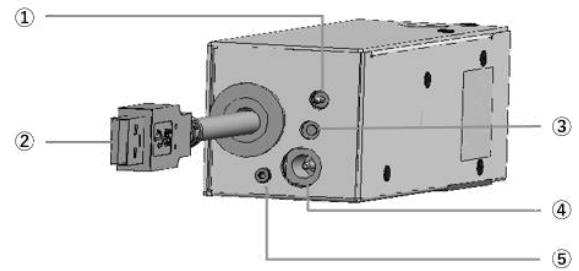

Laser emission surface (front)



Careful

Do not irradiate the human body, eyes, skin, or any other object for which safety has not been confirmed.

2.6 System Configuration Example

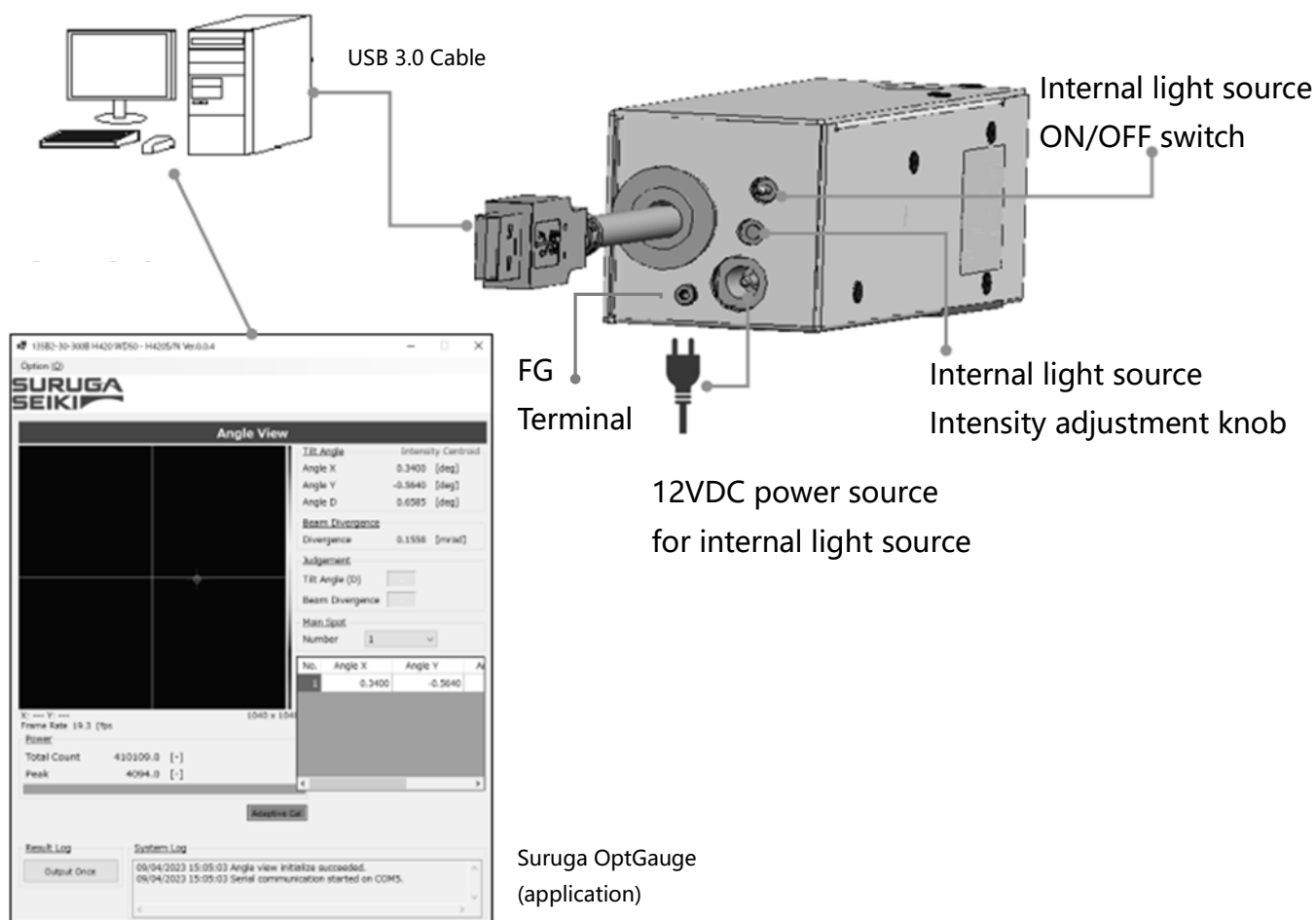

2.7 Required Parts for Configuration

- H420 body
- The power source for internal light source (the AC/DC adapter included)
- A computer, a monitor, and a keyboard to be connected to H420 (prepared by the customer)
- Suruga OptGauge measurement software for the Products

2.8 H420 Installation Method (Example)

This section illustrates mounting methods for the H420 Series. Fix the Products along with the 2-axis Compact Tilt Stage (model: HB10), a Suruga optical sensor common accessory, to the High-Rigidity Stand (model: HA12).

- I. Fix the H420 and an adapter plate (sold separately) for the HB10 with hex socket head cap bolts (model: CBM4x8).

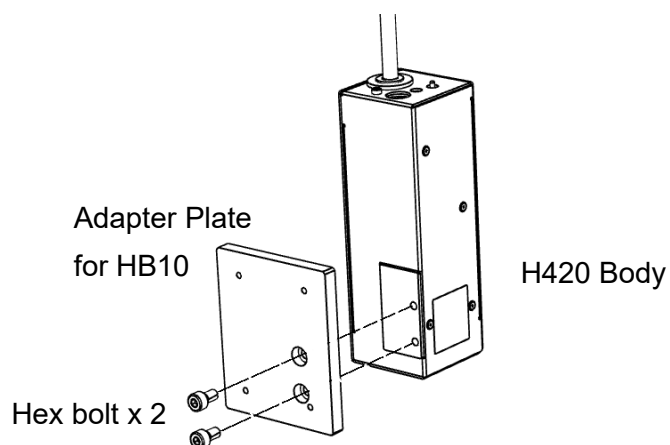

- II. Fix the HB10 and H12 with hex socket head cap bolts in the 4 locations.

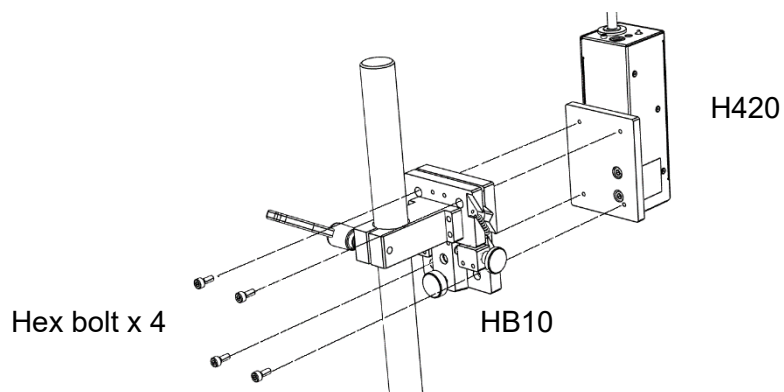

- III. Fasten the HB10.

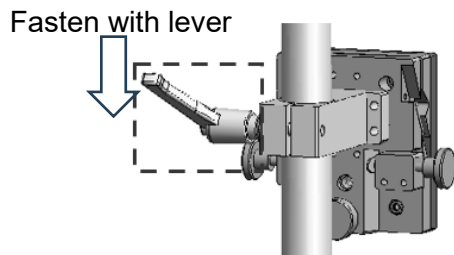

Image of the assembled devices (example)



2.9 Connecting the power to the Internal Light Source

Please use only the proper AC/DC adapter.

Insert the DC plug of the AC/DC adapter into the designated socket before inserting the AC side into an outlet. Note: you should ground the FG terminal.

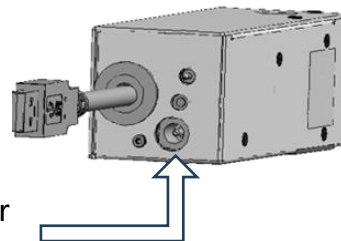

Attention

Do not turn on the AC adapter until software installation is complete.

Please ground the FG terminal to prevent malfunctions caused by electrical noise.

2.10 Connection to a Computer

Connect the USB3.0 cable to a USB port compatible with USB3.0.

Be sure to use a computer with a USB3.0-compatible port.

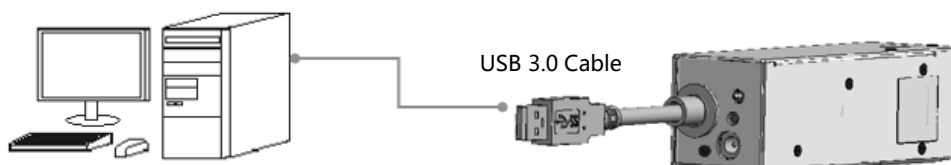

Attention

Do not disconnect the USB cable while the application is running. Normal operation will be disrupted. If the cable disconnects, close the application, reinsert the USB cable, and restart the application.

2.11 Software - Installation of Suruga OptGauge

2.11.1 Software License

To use Suruga OptGauge (hereafter as "this software"), the customer must consent to the following software license agreement (hereafter as "this agreement").

When installing or copying all or part of this software on a computer, or using this software after installation, it is considered that the customer has consented to all terms of this agreement, and the agreement is bilaterally concluded.

Article 1 (Permissions)

This software is for free of charge.

The copyright for this software, its manual, and other documents concerning this software belongs to SURUGA SEIKI Co., Ltd. (hereafter as "Suruga"). Suruga grants all users for non-proprietary rights to the use of this software.

Article 2 (Usage Restrictions)

Suruga permits this software to use only for the purposes of operating the Products and collecting data. Suruga prohibits a use for any other purposes.

Article 3 (Reproduction and Modification)

This software can be copied only to computers using the Products. However, Suruga prohibits Modification, redistribution, and reverse engineering.

Article 4 (Disclaimers)

1. Users make use of this software on their own responsibility.
2. Suruga bears no responsibility and is not liable for any direct, indirect, incidental, special, supervenient, or punitive damage including but not limited to; data loss, business interruptions, and loss of profit, incurred arising out of or failure to use this software.
3. In addition, Suruga bears no responsibility and is not liable for any damage incurred arising out of software bugs, errors, viruses, malfunctions due to illicit third-party access, or security issues with this software.
4. Suruga bears no responsibility and is not liable to damages incurred upon modification of the software.

Article 5 (Support)

Suruga provides technical support for this software. However, there is no guarantee that our technical support will achieve customer's purpose.

Article 6 (Termination of Agreement)

The rights to use this software will be, immediately, terminated upon violation of the conditions of this agreement.

2.11.2 Recommended operating system environment for installation

Hardware requirements	Supported OS	Windows 10 Pro 64it
	CPU	Intel Core i5 - 10400 CPU 2.90GHz or higher 6-core 12-thread
	RAM	8GB or higher
	Storage capacity	1GB or higher
	Display resolution	1920 x 1080
	USB	USB3.0 (type A) port: 2 or more
Software requirements	Framework	NET6.0*

*If NET6.0 is not installed on your computer, install "NET RunTime 6.0.x.x" from the Microsoft website.

2.11.3 Installation of Suruga OptGauge

2.11.3.1 Installation of the USB device driver

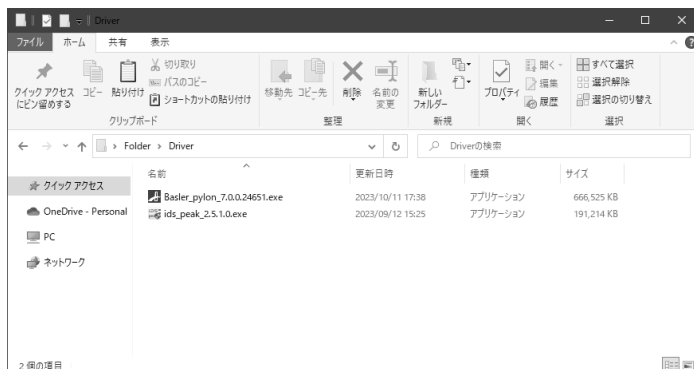

1. Double-click the "... \Driver" "Basler_pylon_7.0.0.24651.exe" to begin installation.
2. Consent to your installation on the confirmation screen.
3. Set the installation method (Profiles) to "Developer."

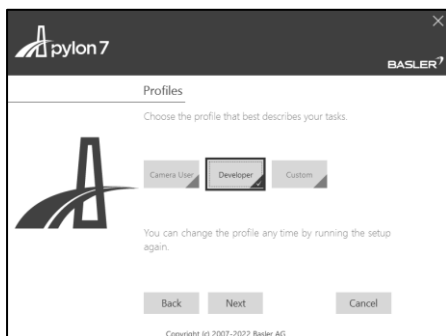

4. Set the sensor camera connection method (Interfaces) to "USB." Thereafter, use the default settings to complete the installation.

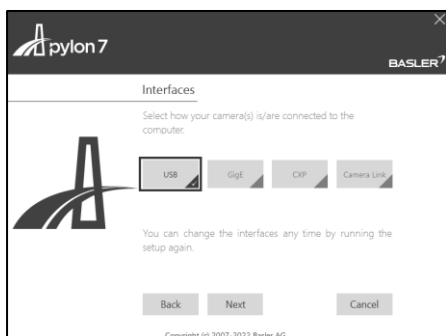

2.11.3.2 Download Only

Where to download: the Suruga website (<http://jpn.surugaseiki.com/>).

2.11.3.3 Installation of Suruga OptGauge

Install this software, "Suruga OptGauge" (hereafter as OptGauge).

1. Double-click "SurugaOptGaugeSetup_x.x.xx.msi" in the directory "... ¥Application".

Name	Date Modified	Type	Size
 SurugaOptGaugeSetup_x.x.x.msi		Windows インストー...	61,590 KB

2. Click "Next>".

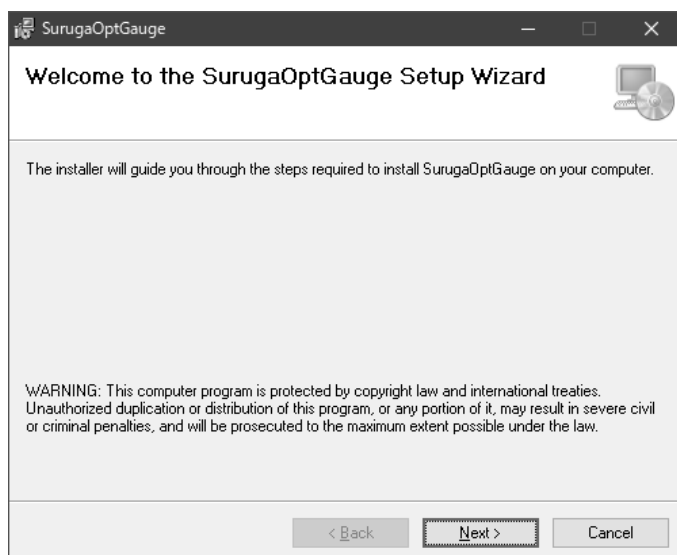

3. Click "Next>" to begin installation.
When installation is complete, click "Close".

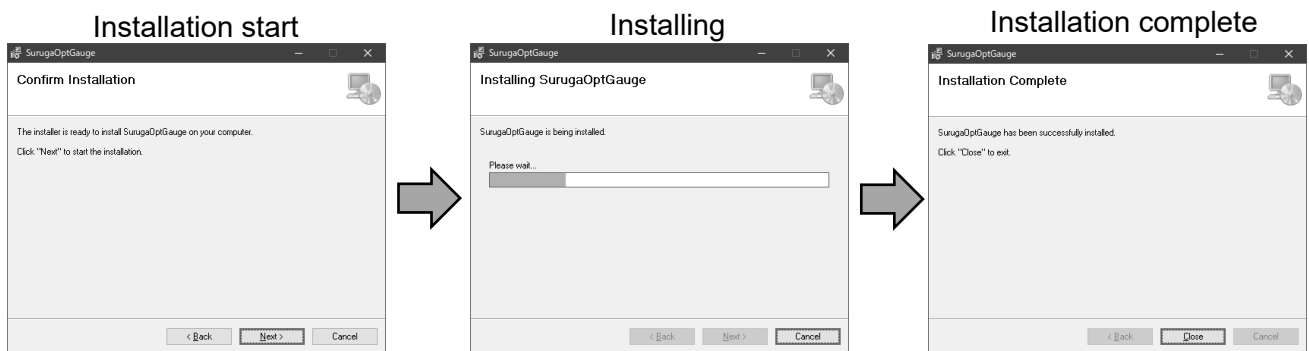

4. OptGauge will be created on the desktop.



The installation procedures are complete.

2.11.3.4 Copy of Device Authentication File

Caution: Authentication file

For the H420 series, calibration values are set for each device. Therefore, the "Suruga OptGauge" requires the reading of a "device authentication file (dot suruga extension)" in which the unique information of individual device is stored.

To load the device authentication file into the installed Suruga OptGauge, copy the file "xxx.suruga" in the "... /AuthenticationFile" to an arbitrary file location.

名前	更新日時	種類	サイズ
xxx.suruga		SURUGA ファイル	6 KB

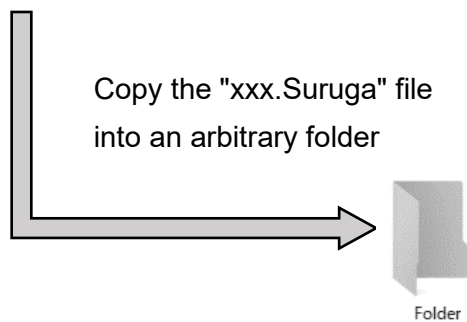

Note

If your security does not allow you to copy the device authentication file into your PC, this procedure is not necessary because the file can be read directly from the USB memory stick provided included in the Products.

2.11.3.5 OptGauge Startup / Shutdown

OptGauge startup

1. Double-click "SurugaOptGauge" in the "...¥Desktop".



Click on "..." in the item "Device Authentication File" and select the extension ".suruga" in the folder in which the unique "Device Authentication File" was copied.

If not able to copy the device authentication file to your computer, select it directly from the USB memory stick.

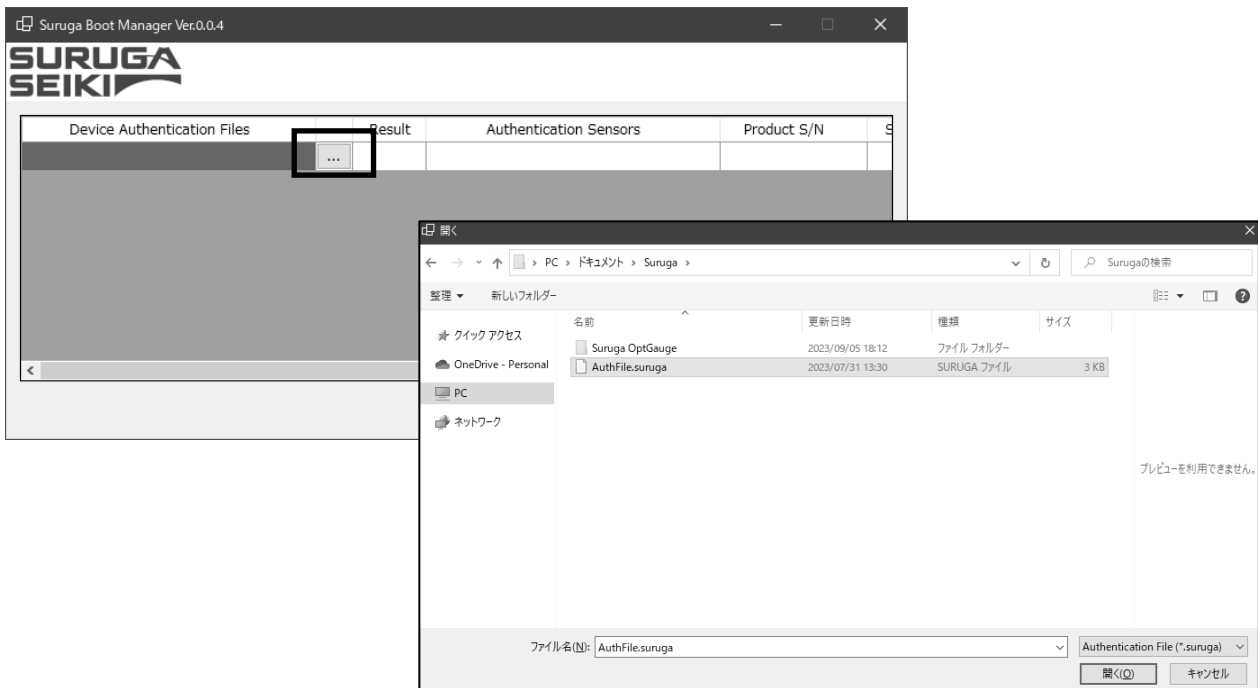

3. Confirm that the "Result" is "OK" and click "Start."

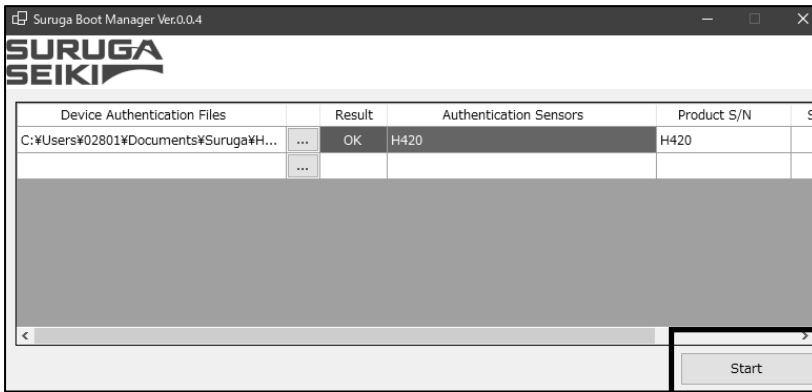

Caution

*Because this application is equipped with TCP/IP communication control, the following warning may appear upon initial startup, depending on your computer's security settings. If your computer and network environment allow the TCP/IP communication permission, check all, and click "Allow access".

If not, click "Cancel".

(Changes can be made after the fact in "Control Panel ¥ All Control Panel Items ¥ Windows Defender Firewall ¥ Allowed Apps".)

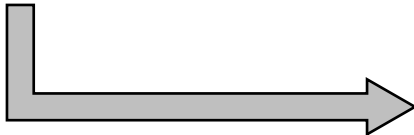

4. The application will start up.

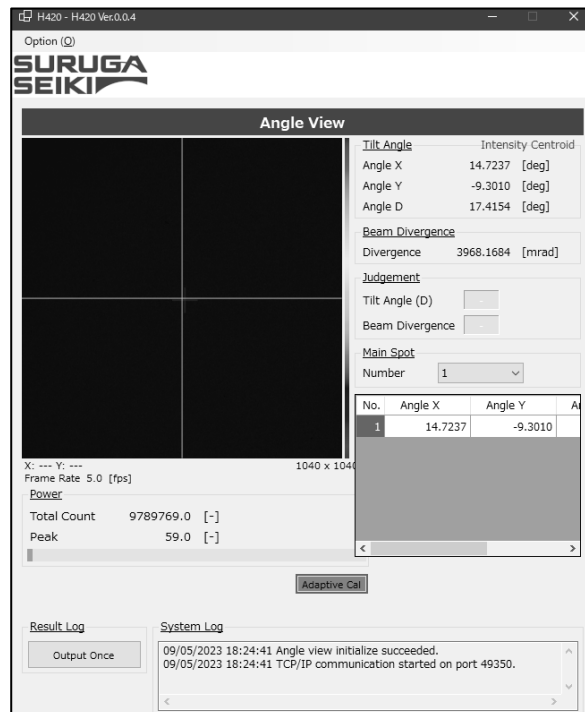

OptGauge shutdown

1. Click the "x" button to shut down OptGauge.



2.12 Turning the Power On



Do not turn on the sensor head power until the H420 and the software installation on your PC are completed and a supervisor has confirmed work safety.

To turn on the internal light source, connect the DC12V power adapter for internal light source to an outlet and set the internal light source ON/OFF switch to ON.

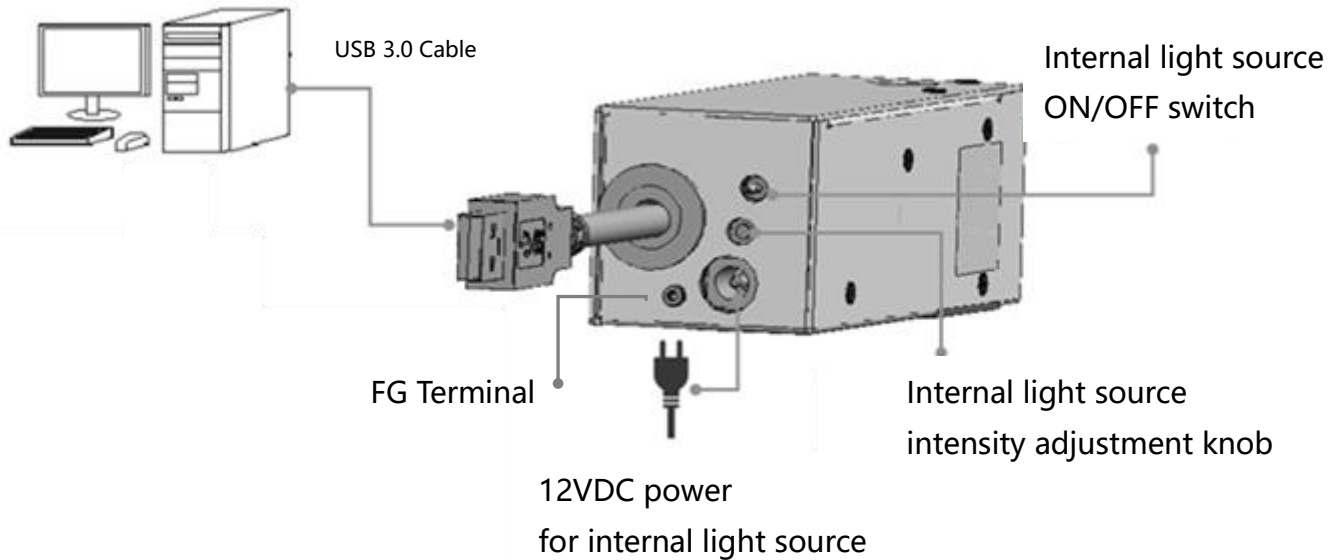

3. Settings

This section describes settings for the sensor head, using the H420 Series dedicated software Suruga OptGauge.

3.1 Sensor Head Usage Precautions and Setting (Installation) by Model

3.1.1. Mounting (with HB10)

Move HB10 (the tilt stage) up and down to adjust the distance between the sensor head and the measurement target (W.D.).

Loosen the lever and move the product up and down

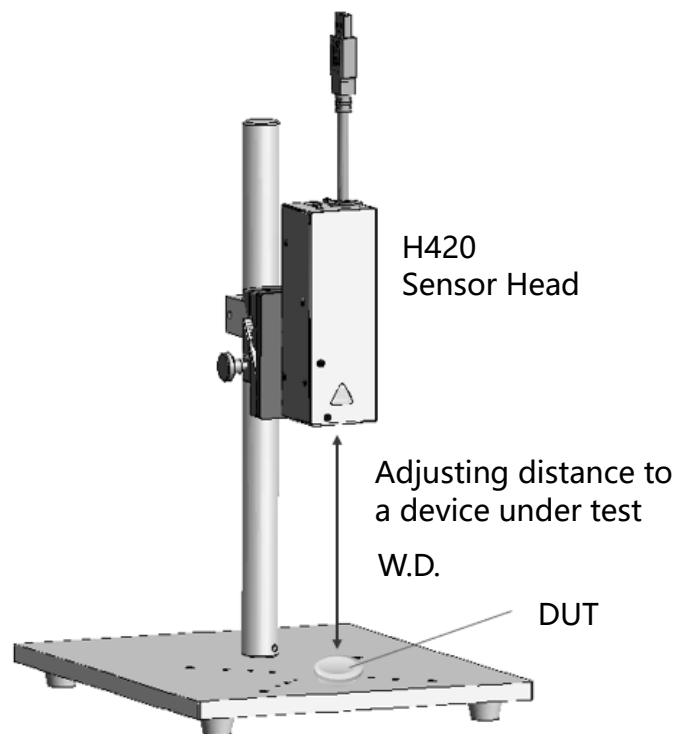
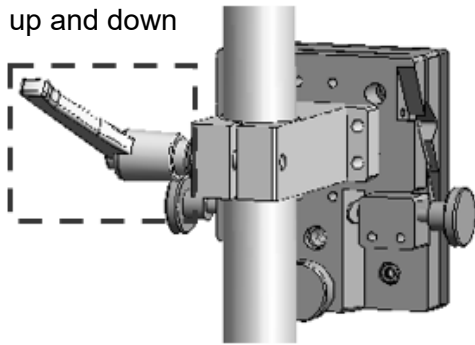

3.1.2. For reflection angle measurement

1. When installation is complete, turn the internal light source switch ON.

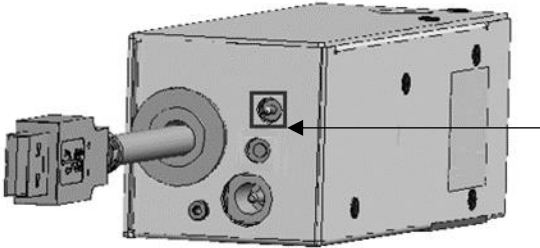

Internal light source switch
(lit up at powered state)

2. Launch OptGauge and open the option screen.

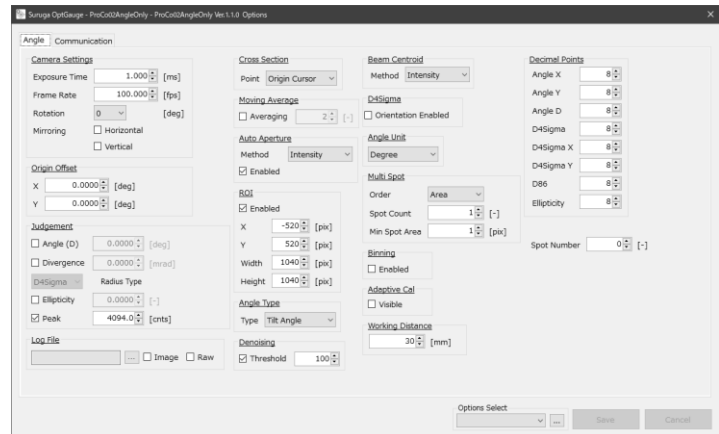

3. Input the working distance (W.D.) between the sensor head and a device under test (DUT) into "Working Distance*" in the option screen.
*see "Working Distance" in the Measurement Option Setting for details.
4. Set the Angle Type to "Tilt Angle*" in the option screen.
*see "Angle Type" in the Measurement Option Setting for details.
5. Adjust the Exposure Time*1 on the option screen and, with the screwdriver for light intensity adjustment, turn the knob to adjust the light intensity to set the value between 3500 and 3800 (optimum value) while checking the Peak*2 on the measurement screen.
*1 see "Camera Settings" in the Measurement Option Setting Details section.
*2 see "Power" in the OptGauge Main Screen Details section.

3.1.3. For external light angle measurement

- 1 Turn the H420 internal light source OFF and irradiate a beam from an external light source to the H420 front lens.

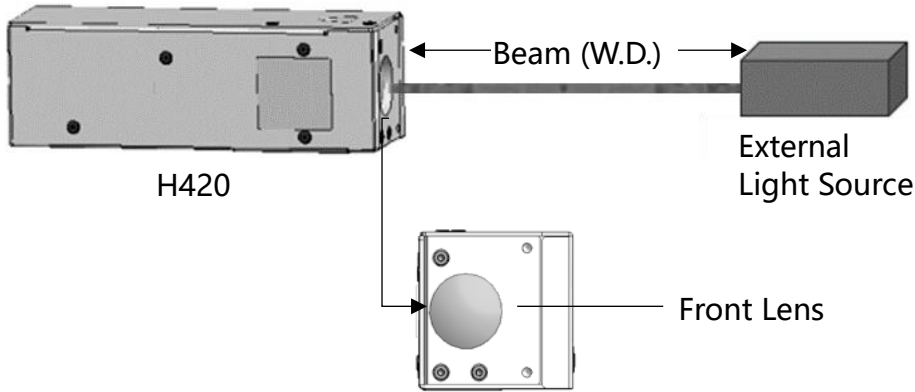

- 2 Launch OptGauge and open the option screen.

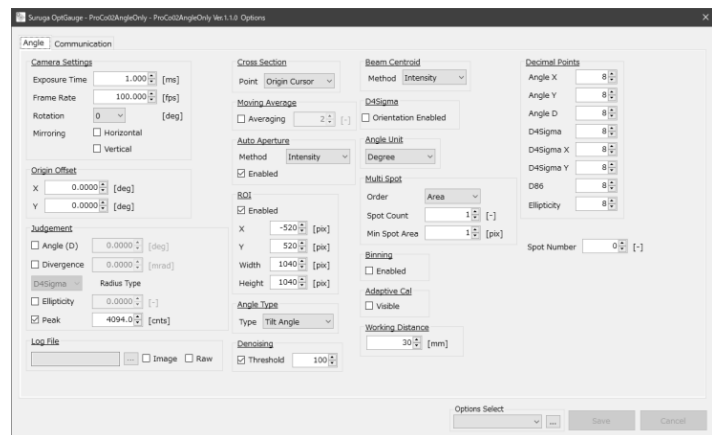

- 3 Align the beam onto the sensor head lens, find working distance (W.D.) between the sensor head and the external light source, and input the W.D. into "Working Distance*" in the option screen.

*see "Working Distance" in the Measurement Option Setting Details section

- 4 Set the "Angle Type*" to "Beam Angle" in the option screen.

*see "Angle Type" in the Measurement Option Setting Details section.

5 Adjust the "Exposure Time*1" on the option screen and the external light source intensity; set between 3500 and 3800 (optimum value) while checking the "Peak*2" in the measurement screen.

*1 See "Camera Settings" in the Measurement Option Setting Details section.

*2 See "Power" in the OptGauge Main Screen Details section.

3.2 Names and Functions in the OptGauge Software Main Screen

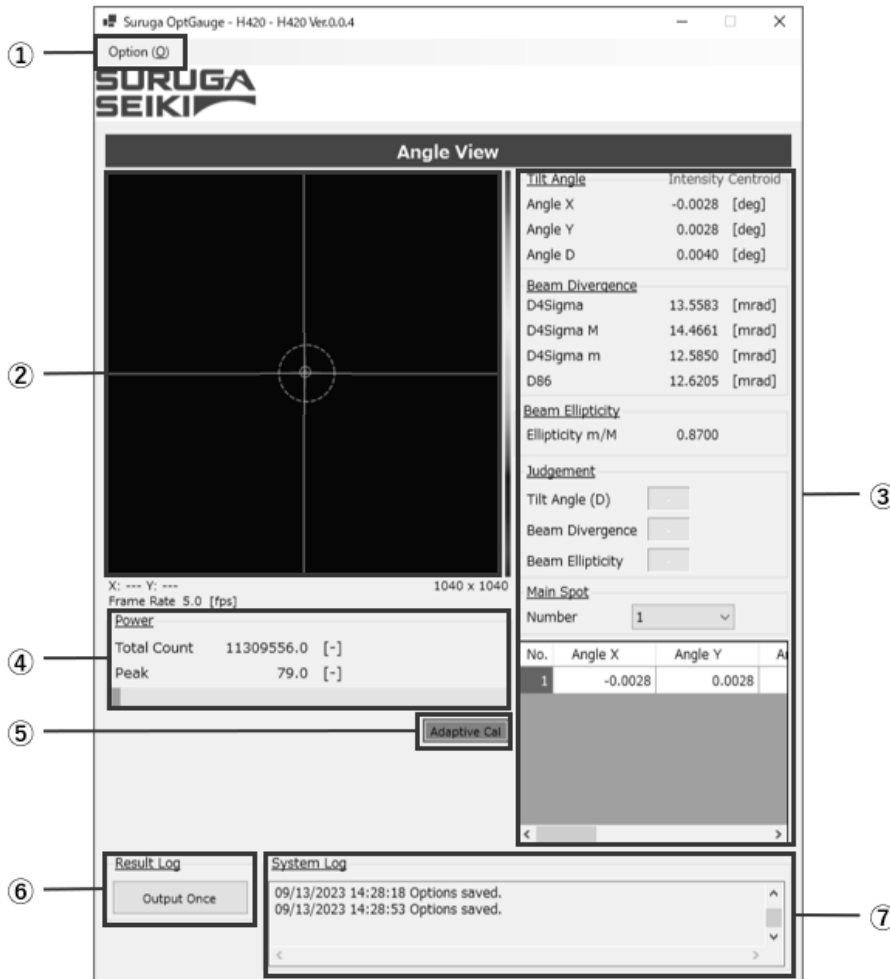

OptGauge Main Screen

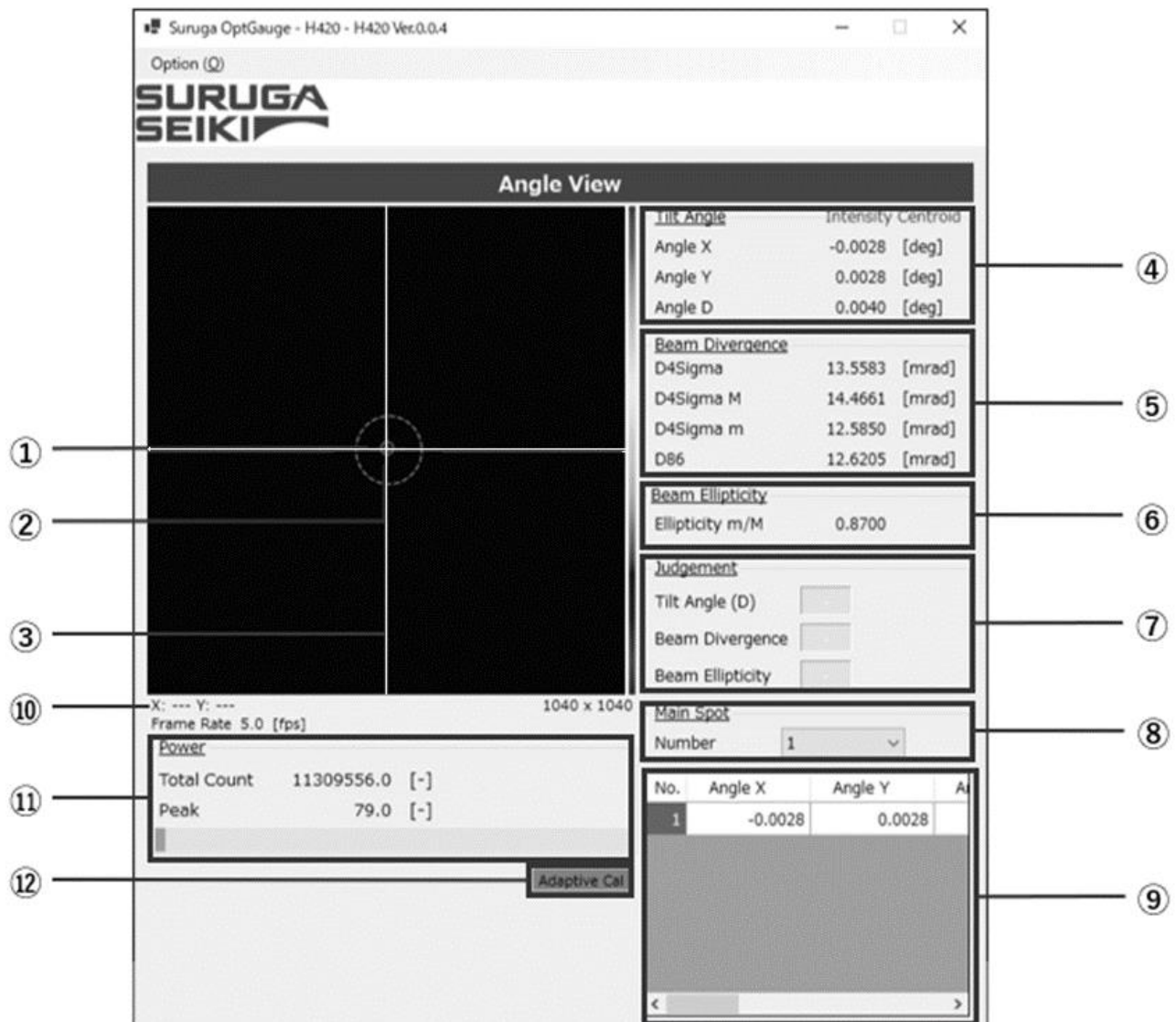

① Option	Opens the option dialog box.
② Angle View	Display area for images taken with the sensor camera.
③ Measurement Results Display	Angle measurement results display area.
④ Power	Beam strength display area.
⑤ Adaptive Cal	Executes adaptive calibration (denoising).
⑥ Result Log	Outputs measurement results and measurement images to the designated folder on the computer.
⑦ System Log	Display area for application operation log.

3.2.1 OptGauge Main Screen Details



① Cross (red)	 Displays beam center position.
② Aperture (blue, orange)	 Restricts measurement calculation target area. *See "Aperture" in the Function for details
③ Cross (white)	 Displays a coordinate center position.

④ Tilt Angle/ Beam Angle	The measurement mode changes with "Angle Type*" in the option settings. *See "Tilt Angle/Beam Angle" in the Function for details	
	Angle X	Displays an angle X from the X-axis component of the white cross at center.
	Angle Y	Displays an angle Y from Y-axis component on the white cross at center.
	Angle D	Displays an angle on the center of the cross (white).
⑤ Beam Divergence	The measurement mode changes with "D4 Sigma" -> "Orientation Enabled" in the option settings. *See "Beam Divergence" in the function details section.	
	D4 Sigma	Displays $D4\sigma$ beam width divergence in half angle.
	D4 Sigma X(M)	Displays $D4\sigma$ X(M) beam width divergence in half angle.
	D4 Sigma Y(m)	Displays $D4\sigma$ Y(m) beam width divergence in half angle.
⑥ Beam Ellipticity	Functions when enabling "D4Sigma" --> "Orientation Enabled" in the option settings." *See "Beam Ellipticity" in the function details section.	
	Ellipticity m/M	Displays the $D4\sigma$ beam width ellipticity.
⑦ Judgement	Functions when marking a check <input checked="" type="checkbox"/> for a measurement data you wish to judge in the "Judgement Settings" in the option settings, and meanwhile entering the Judgment criteria with the value entry <input .<br="" type="text" value="0.0000"/> *See "Judgement" in the function details section.	
	Tilt Angle (D)	Displays "OK" when the set judgement criteria are satisfied and "NG" if not.
	Beam Divergence	
	Beam Ellipticity	
⑧ Main Spot	Number	Designates displaying beam spots. "④ TiltAngle/BeamAngle" while measuring multiple beam spots.
⑨ Multiple Spot Measurement Display	Automatically lists and displays beam spot measurement results for when multiple beam spots are detected.	
⑩ XY Coordinates	Displays the coordinates where the mouse cursor pointing.	

⑪ Frame Rate	Displays the image update speed per second until measurement data calculations from captured image data are complete.	
⑫ Power	Total Count	Displays beam total count value from 0 to 4,429,152,000.
	Peak	Displays beam maximum luminance value from 0 to 4095.
⑬ Adaptive Cal	Removes noise from overall images captured by the sensor camera in to improve calculation accuracy. *See "Adaptive Calibration" in the Function Details section	





3.3 Function Details (and Parameter Detail Settings)

3.3.1 Tilt Angle/Beam Angle

You need to change the measurement mode according to your measuring purpose.

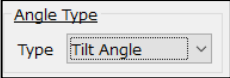
For the reflection angle measurement, select "Tilt Angle".

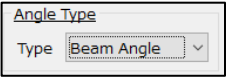
For the external light angle measurement, select "Beam Angle".

For the reflectance angle measurement	
<p>Set "Angle Type" in option settings to [Tilt Angle]</p> 	<p>It starts reflection angle measurement.</p> 
For the external light angle measurement	
<p>Set "Angle Type" in option settings to [Beam Angle].</p> 	<p>Starts external light angle measurement.</p> 

3.3.2 Divergence

Divergence indicates how much the light beam expands at an angle as it propagates. A light beam with small divergence means that there is little expansion during propagation over long distance, while a beam with a large divergence expands rapidly over short distance.

The Products display divergence in a half-angle with mrad (milli radian). It has two modes of measurement.

To measure $D4\sigma$ beam diameter (elliptical beam) of divergence along with X-axis and Y-axis directions.

Set "Orientation Enabled" in the option settings to "Disabled".

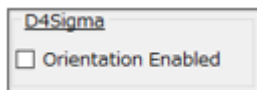

Measures beam divergence with "D4Sigma X" and "D4Sigma Y"

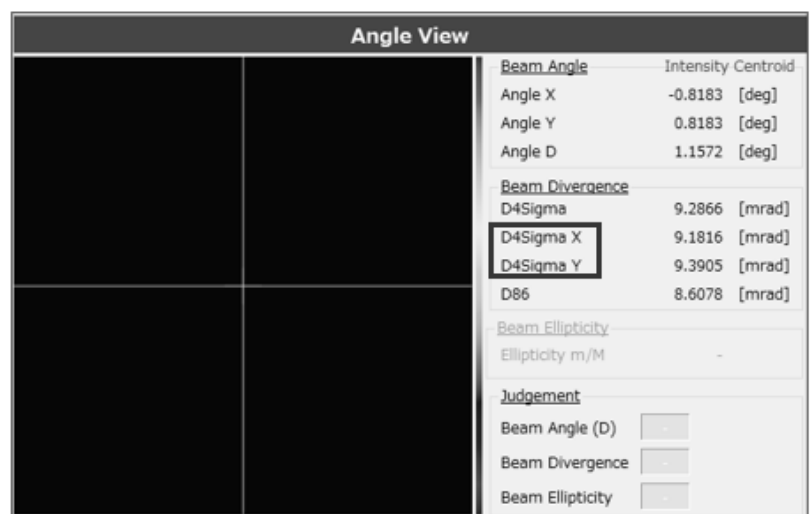

To measure a $D4\sigma$ beam diameter (elliptical beam) of divergence along with M (major: long axis) and m (minor: short axis).

Set "Orientation Enabled" in the option settings to "Enabled".

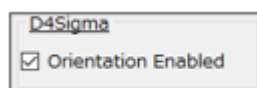

Measures beam divergence with "D4Sigma M" and "D4Sigma m"

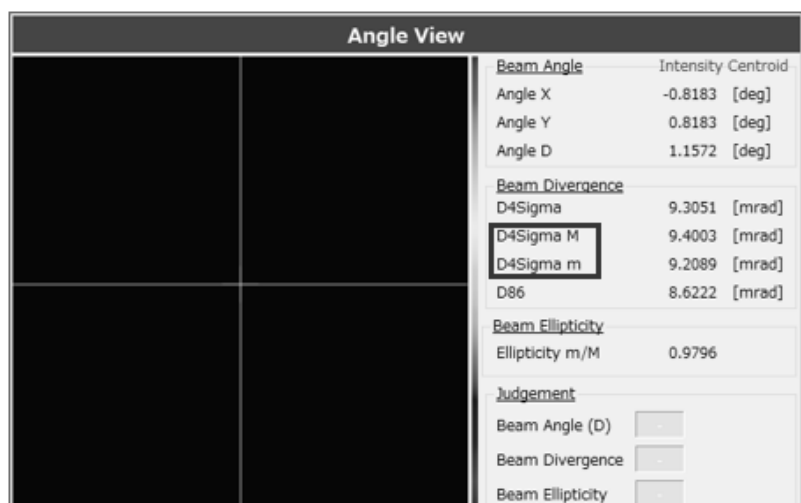

3.3.3 Beam Centroid

The center position of a light spot can be selected by the type either beam area (area centroid) and beam intensity (luminance centroid) in the "Beam Centroid" in the option setting. It is recommended to select the type of "Beam Centroid" according to an object to be measured.

Area Centroid (Area)

For the area centroid of a light beam, its centroid position is calculated from an irradiated area higher luminance than the denoising threshold value and results as an angle. Therefore, by raising the threshold value, the effects of the edges of the peak profile can be minimized.

It is recommended to select this type of measurement for objects such mirror with uniform surface and reflects a light beam without blur or smudge*.

- ※ Optically, blur or smudge is defined as, for instance, luminous point with elongating edge profile in normal distribution, half-width deviating largely from normal distribution, or objects with irregular profiles which are not smooth.

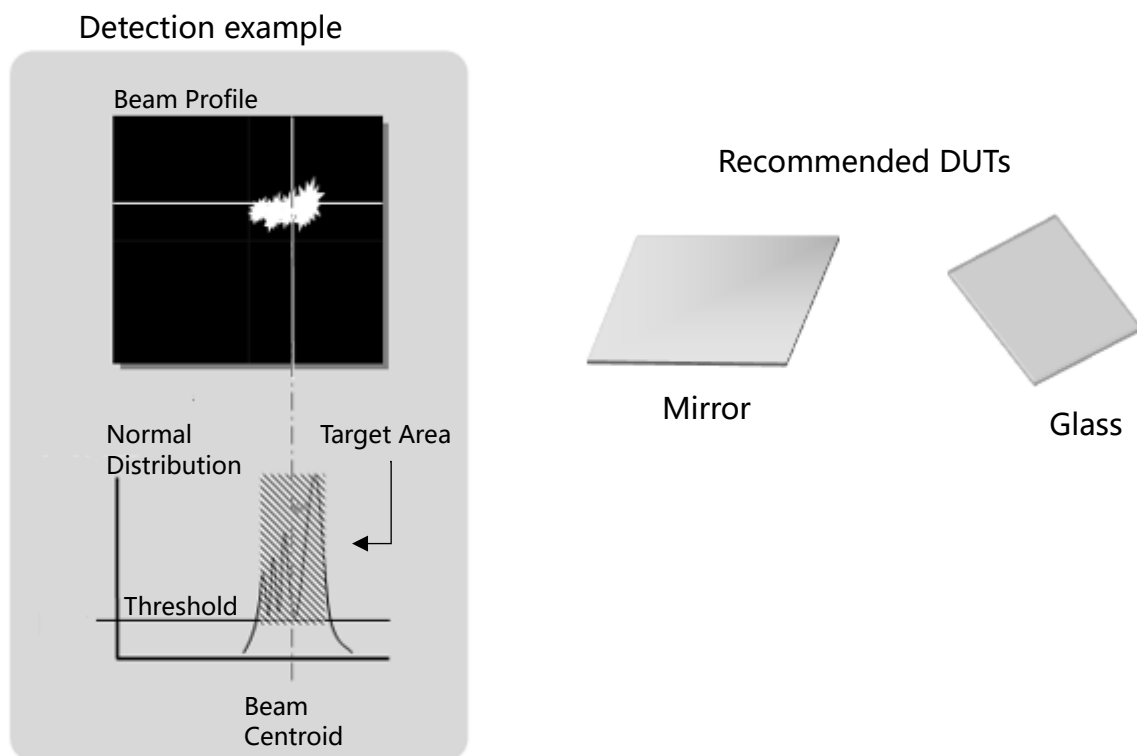

Intensity Centroid

For luminance [Intensity] centroid, the centroid position of a light beam is calculated from the beam intensity with higher luminance than the denoising threshold value and results as an angle.

By lowering the threshold value, the Intensity Centroid can include the luminous point peripheral area causing blur or smudge.

It is recommended to select this type of measurement mode for objects such mirror with uniform surface which reflects a light beam without blur or smudge*.

It is recommended to select this type of measurement mode for objects such as resin with non-uniform surfaces which reflects a light beam with blur or smudge.

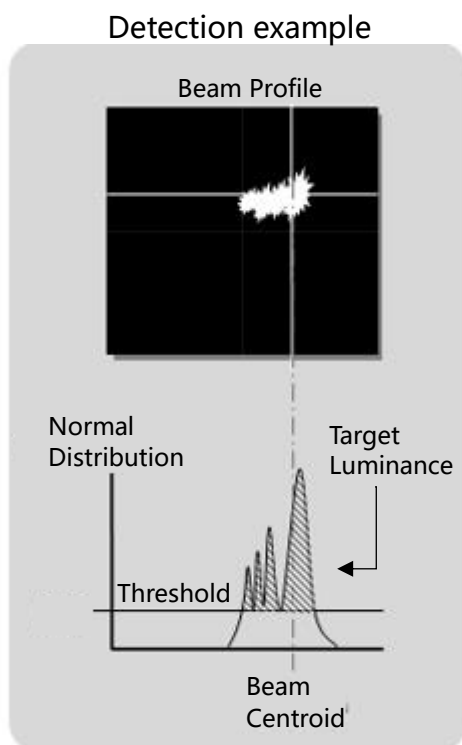

Recommended DUTs



Concave Lens

3.3.4 Beam Ellipticity

Beam Ellipticity determines how far the light beam shape is deformed from circular to elliptical.

Beam ellipticity formula:

$$\text{Beam Ellipticity} = D4 \sigma m \text{ (minor) beam diameter} / D4 \sigma M \text{ (major) beam diameter}$$

The following describes its use.

Beam Ellipticity Usage

1. The beam spots of "Sub 1" and "Sub 2" shown in the right are incident lights on the sensor head, and the angles of each can be measured.

We move the two beam spots close to each other so that the Sub1 and Sub2 are nearly parallel.

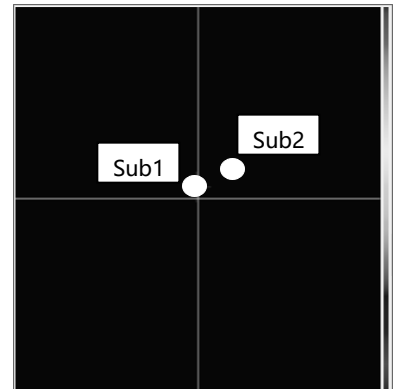

2. As the two beam spots move closer together, the sensor begins to perceive them as a single elliptical beam.

Therefore, it is no longer possible to measure their individual angles or their parallelism.

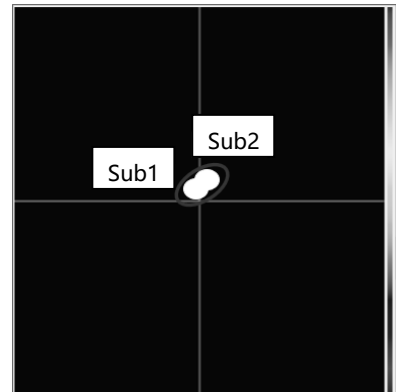

- On this state as mentioned above, the beam ellipticity function should be applied.

The beam is displayed in ellipticity.

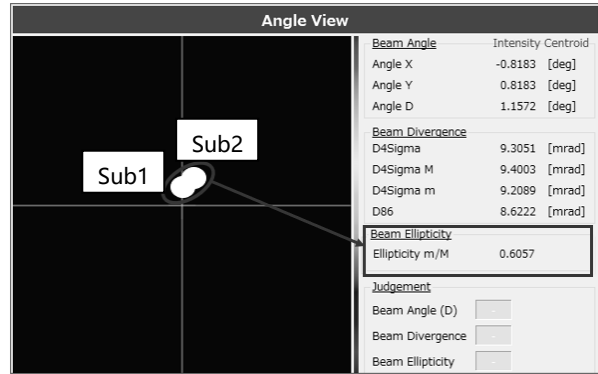

- Move the two beams even closer together. Closer the ellipticity to "1.000" and the two targets are nearer to parallel.

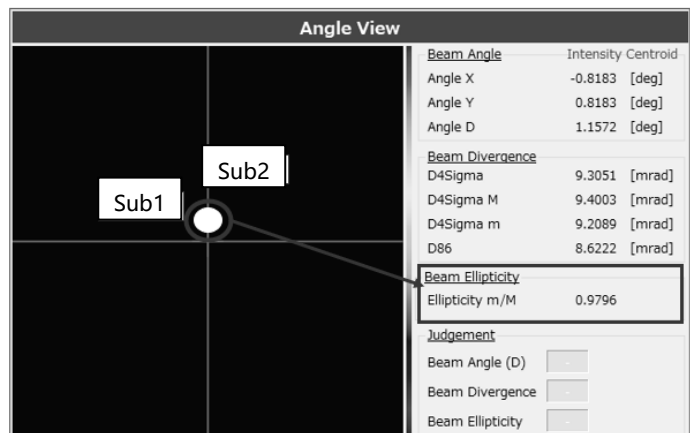

For ellipticity measurement

Set "Orientation Enabled" in option settings to "Enabled".

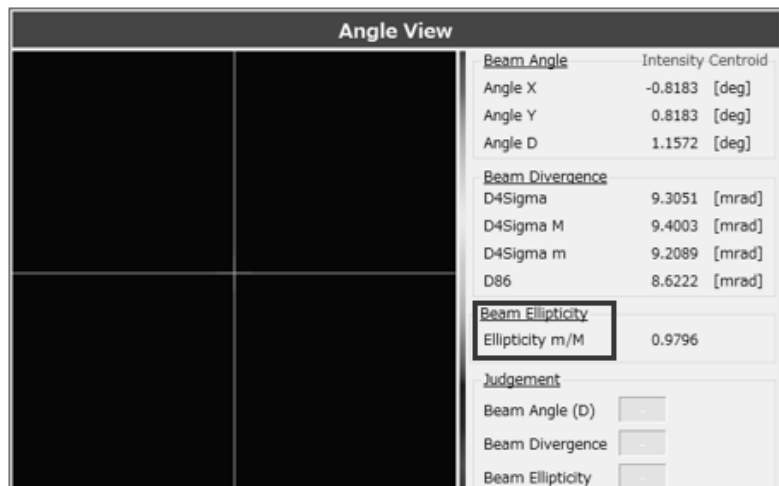
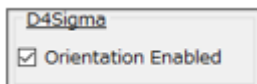

3.3.5 Judgement

The judgement function is available in an intuitively understandable expression of whether the measurement value is within the target range or not.

Here, as examples, we have the procedures for Angle (D) and Peak.

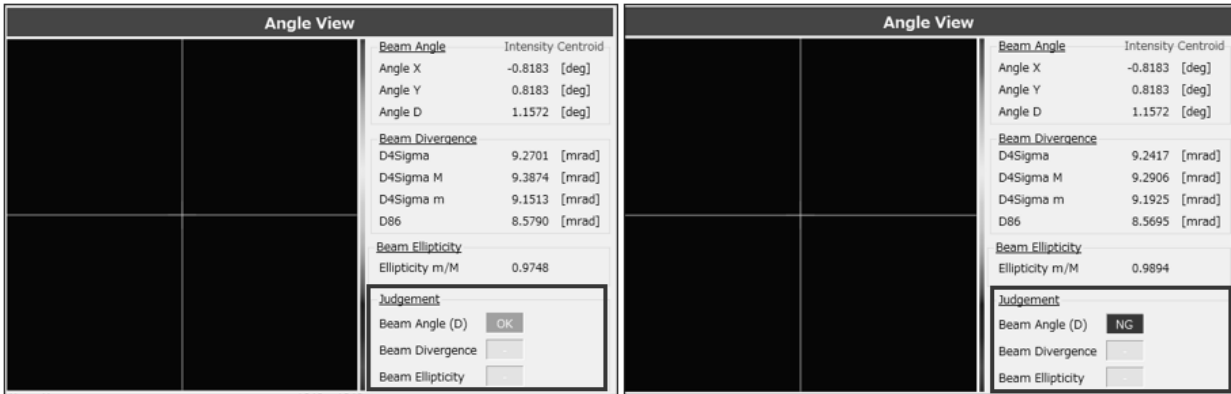

For Angle (D)

- ① Adjusting the angle and aim to set the "Angle(D)" of the measurement result to less than 0.5000.

Enabling the "Angle(D)" in the "Judgement Settings" in the Option setting and enter the value to be "0.5000 deg".

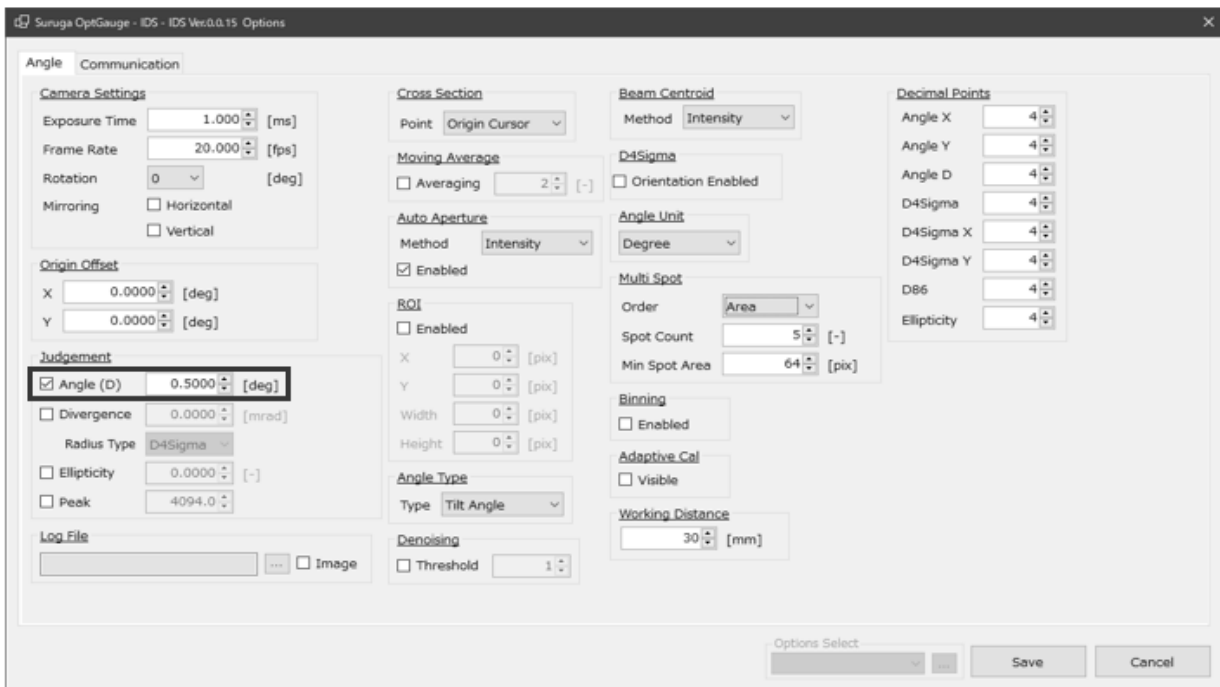

2. As a result of adjusting the angle, the result of Angle D on the measurement screen is not less than 0.5000 deg, so the judgment result is "NG" at the "Tilt Angle(D)" of the "Judgement" .

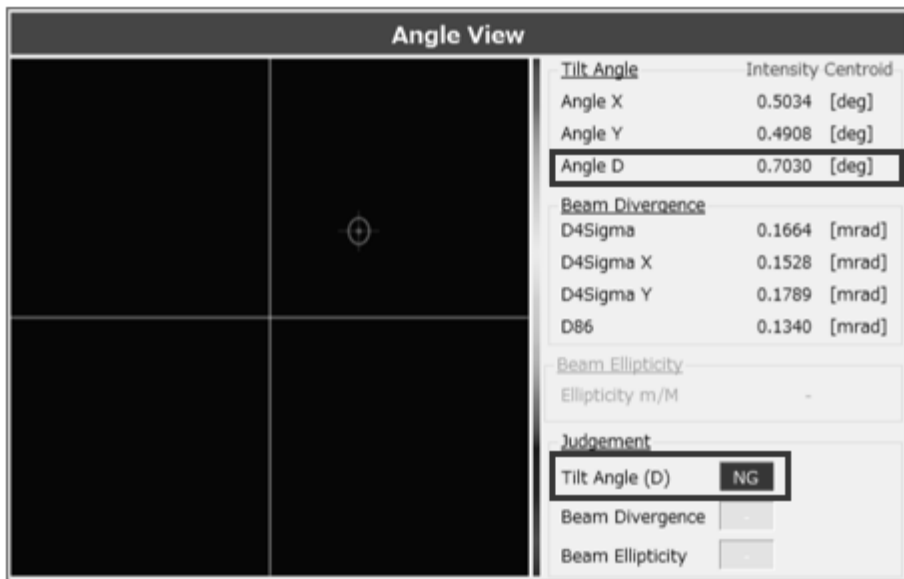

3. As a result of adjusting the angle one more time, the result of Angle D on the measurement screen is less than 0.5000 deg, so the judgment result of "Tilt Angle(D)" in "Judgement" is displayed as OK.

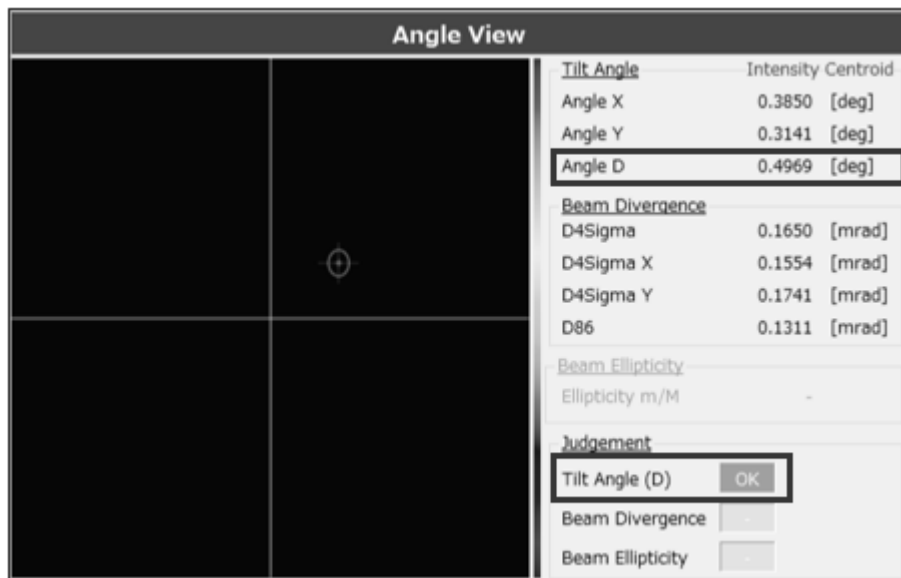

For Peak

1. Adjusting the light intensity and set the “Peak” of the measurement result to be less than 3500.

Set “Peak” to “Enable” in the “Judgement Settings” option and set it to “3500.0.”

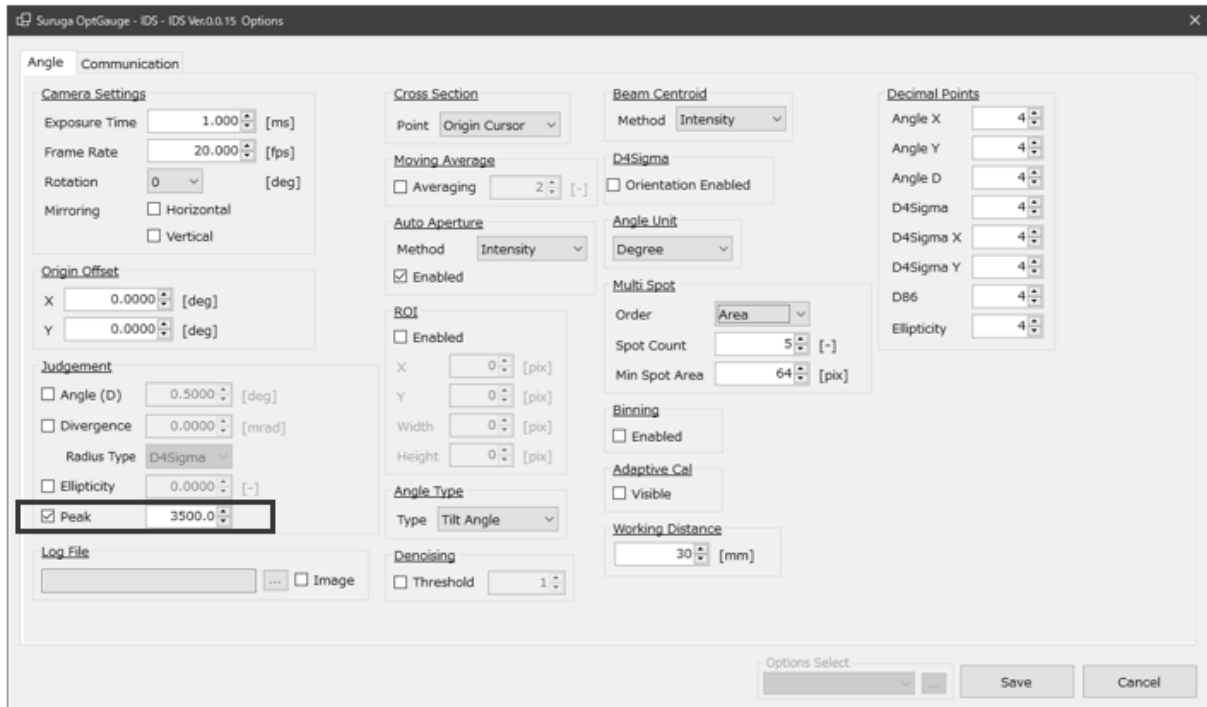

2. Because the result of Peak light intensity adjustment on the measurement screen is not less than 3500.0, the judgement result is “NG,” and the peak bar is in red.



3. When the result of repeated Peak light intensity adjustment on the measurement screen is less than 3500.0, the judgement result is “OK” and the peak bar is in green.

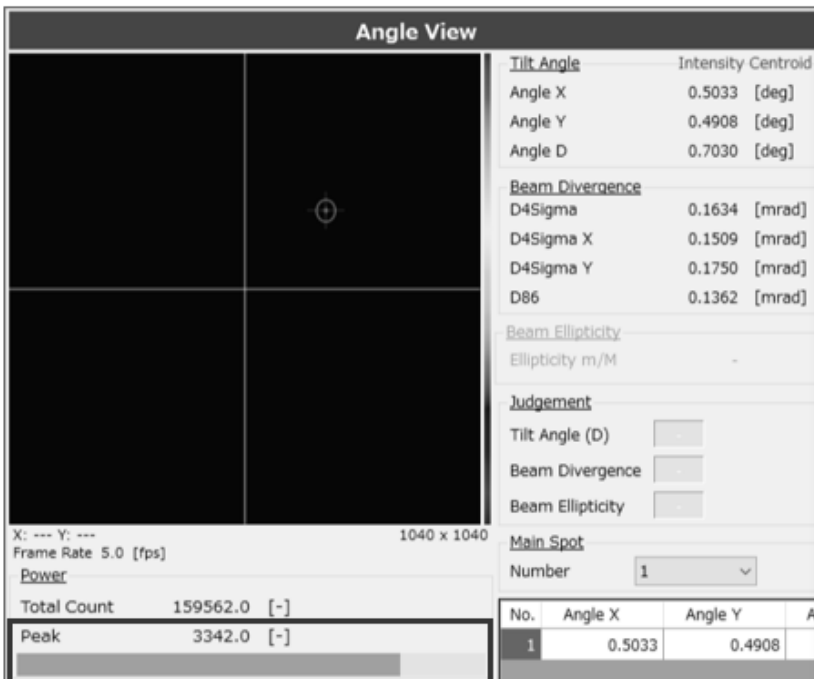

3.3.6 Adaptive Cal

The "Adaptive Cal" is a function that improves beam calculation accuracy by removing noise from the entire sensor. This function is an automatic denoising function that calculates the baseline correction value from the entire sensor and offsets it from the pixel data of each pixel.

It is recommended to run this function when starting up the application and every time the exposure time in the camera settings is changed.

1. Set the beam not to enter the product.
2. Click the "Adaptive Cal" button.

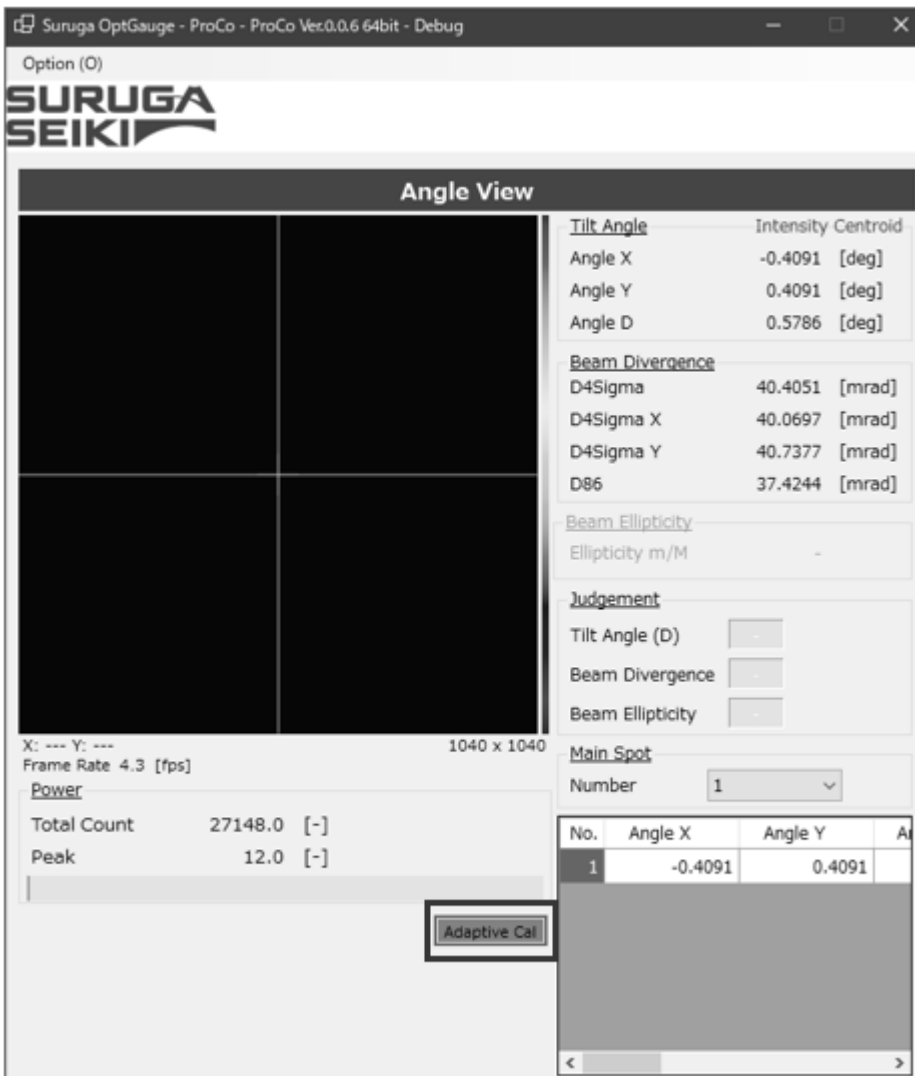

3. When adaptive calibration is executed, the button color changes.
4. When "Adaptive Calibration succeeded" is displayed in the System Log, the process is complete.
5. Thereafter, set the beam incoming to the product and begin measurement.



Note:

If the beam is incoming to the product or the ambient light is causing serious noise, adaptive calibration will not succeed. Execute in an environment where light does not enter the sensor camera.

3.3.7 Aperture

The “Auto Aperture” and “ROI” settings are available to make sure that the effects of noise such as ambient light are not included in the beam divergence measurement results. By using these two functions, measurement excluding ambient light can be done.

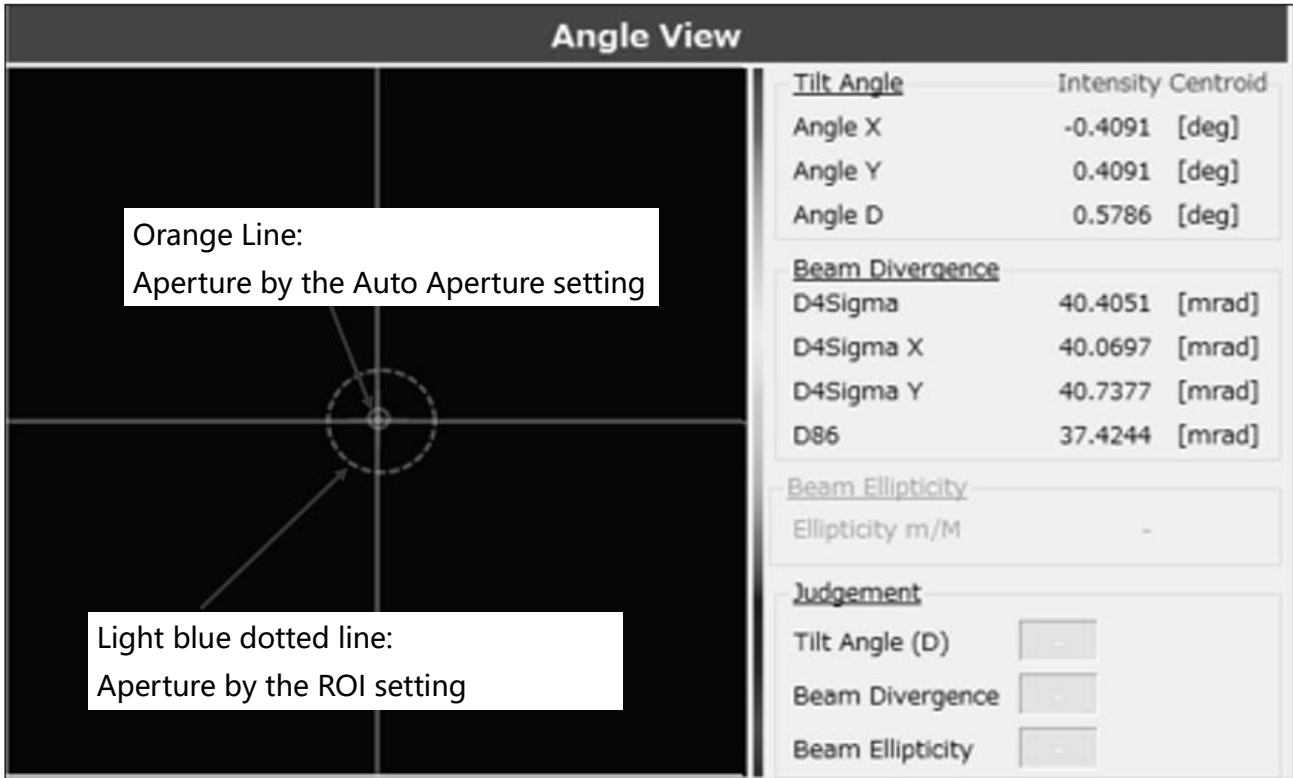

Aperture Explains.

Auto Aperture	This function is suitable for measuring dynamic beams in which the position, size, shape, or intensity of the beam may vary over time. It automatically adjusts aperture.
ROI	This function is suitable for measuring beams in which position, size, shape, and intensity rarely vary with time. The aperture must be adjusted manually.

Info

Auto Aperture and ROI together can enhance only the important parts of the beam intensity, shape, and position, and by minimizing noise and interference it improves the accuracy of measurement.

It is recommended that both be used simultaneously in situations where the beam position does not change.

Setting Methods

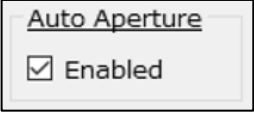
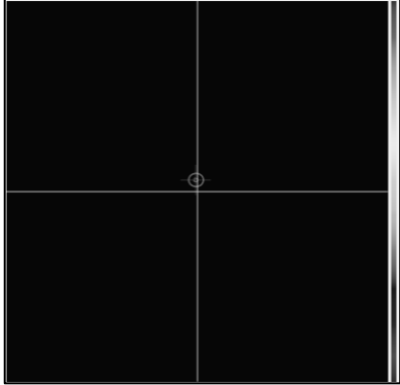
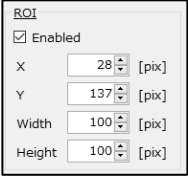
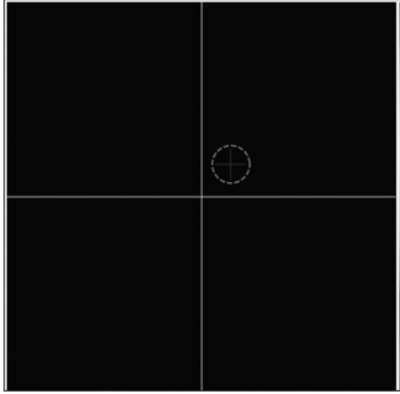
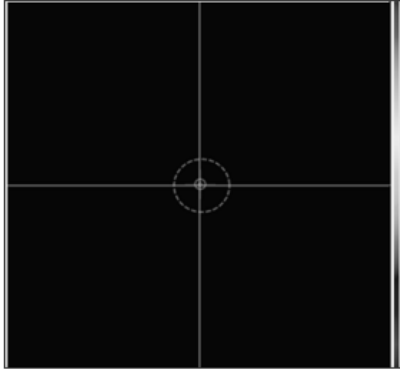
For Setting Auto Aperture	
<p>Set "Auto Aperture" in option settings to [Enabled]</p> 	
For Setting ROI	
<p>Enable "ROI" in the option settings and set the X, position, width, Height (size) to enclose the beam.</p> 	
For Setting Auto Aperture and ROI	
<p>To enclose the light beam, set "Auto Aperture" and "ROI" to "Enable" in the Option Settings, and set the X,Y (location), Width, and Height (size) of the "ROI".</p>	

3.3.8 Origin Offset

The Origin Offset function offsets the sensor camera center position from the default position to any position as desired.

By using the offset function, an arbitrary position can be aligned as the reference position.

There are two offset methods.

Setting Methods

For Setting from the Option Screen

Set "Origin Offset" in option settings to the desired values.

Origin Offset	
X	0.0000 [deg]
Y	0.0000 [deg]

Ex.: Set at X = 0.5deg, Y = 0.5deg

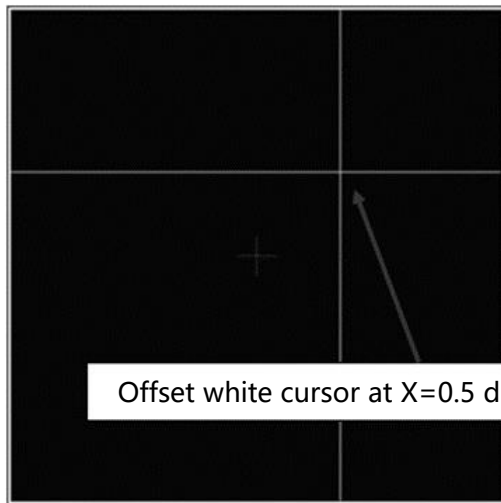

Tilt Angle		Intensity Centroid	
Angle X	-0.5008 [deg]		
Angle Y	-0.5004 [deg]		
Angle D	0.7080 [deg]		
Beam Divergence			
D4Sigma	13.8399 [mrad]		
D4Sigma X	13.7931 [mrad]		
D4Sigma Y	13.8865 [mrad]		
D86	12.8666 [mrad]		
Beam Ellipticity			
Ellipticity m/M	-		

For Setting from the View Screen

1. Open the option setting screen.
2. Target the view screen cross (white) with cursor.
3. When the mouse icon changes, perform "drag and drop."

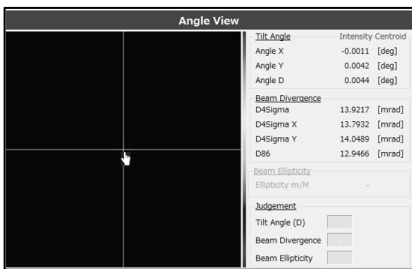

Tilt Angle		Intensity Centroid	
Angle X	-0.0011 [deg]		
Angle Y	0.0042 [deg]		
Angle D	0.0044 [deg]		
Beam Divergence			
D4Sigma	13.9217 [mrad]		
D4Sigma X	13.7932 [mrad]		
D4Sigma Y	14.0489 [mrad]		
D86	12.9466 [mrad]		
Beam Ellipticity			
Ellipticity m/M	-		
Judgement			
Tilt Angle (D)	<input type="checkbox"/>		
Beam Divergence	<input type="checkbox"/>		
Beam Ellipticity	<input type="checkbox"/>		

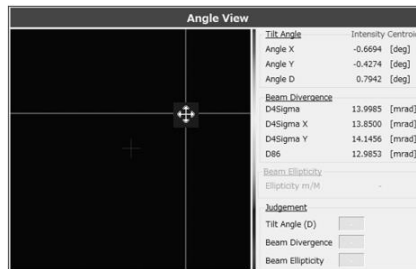

Tilt Angle		Intensity Centroid	
Angle X	-0.6694 [deg]		
Angle Y	-0.4274 [deg]		
Angle D	0.7942 [deg]		
Beam Divergence			
D4Sigma	13.9985 [mrad]		
D4Sigma X	13.8500 [mrad]		
D4Sigma Y	14.1456 [mrad]		
D86	12.9853 [mrad]		
Beam Ellipticity			
Ellipticity m/M	-		
Judgement			
Tilt Angle (D)	<input type="checkbox"/>		
Beam Divergence	<input type="checkbox"/>		
Beam Ellipticity	<input type="checkbox"/>		

4. Once changing "Origin Offset", save the Option settings.

Origin Offset	
X	0.6747 [deg]
Y	0.4445 [deg]

3.3.9 Zoom In

A zoom function is available for observation of the light beam status on the View screen.

1. Left-click the view screen.
2. A pop-up window will be displayed.

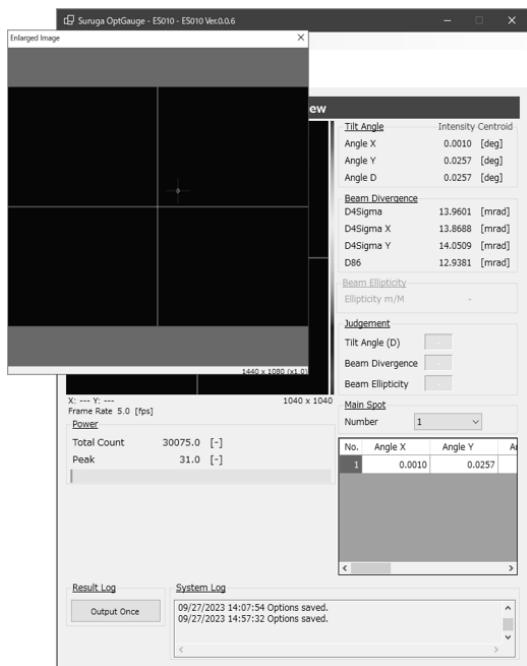

3. Drag and drop the display to be enlarged, and a zoomed area will appear.

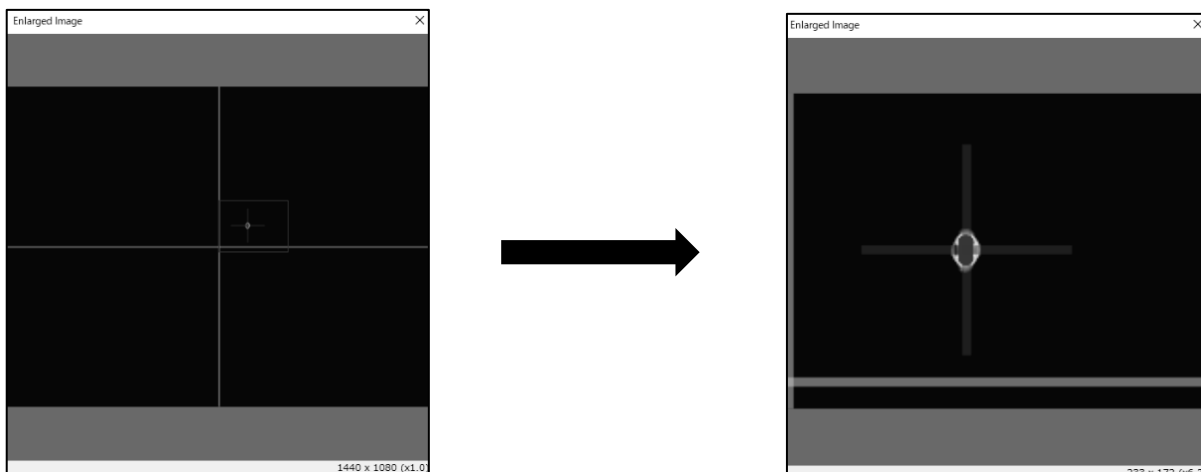

4. Right-click to quit the zooming display.

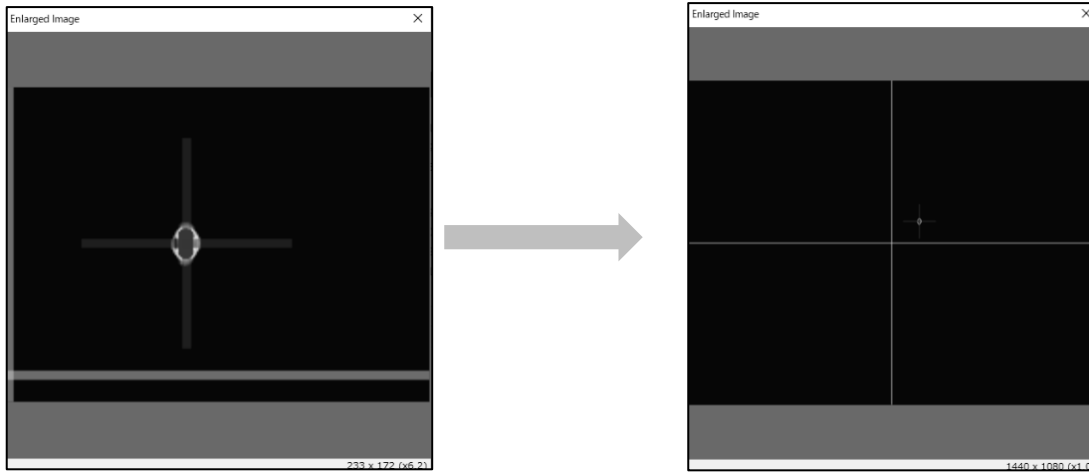

5. To close the pop-up window, click the [X] button.

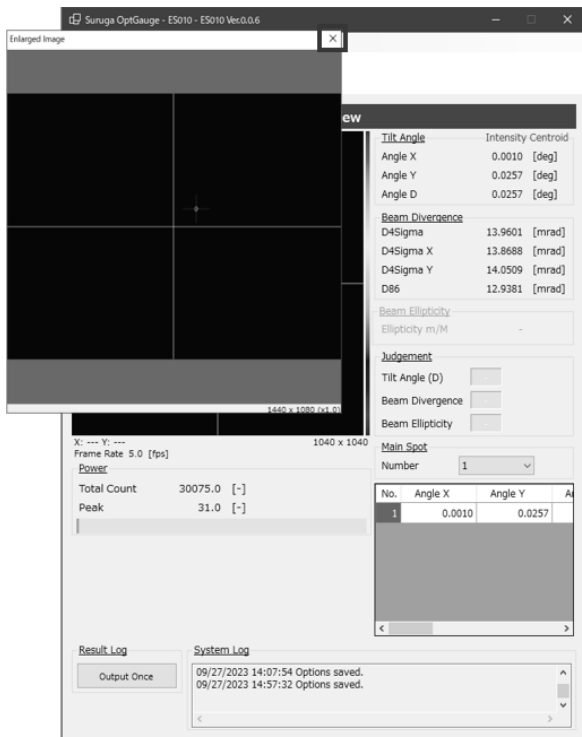

3.3.10 Multi Spot

The Products support multi-spot measurement of up to 100 spots simultaneously. The use of the Multi Spot setting enables the measurement results screen display order and number to be set.

Detection conditions can also be set to filter measurement targets.

Ex. Explaining the screen for detection of multiple beams (4 spots)

The screenshot shows the SURUGA SEIKI OptGauge software interface. The main window is titled 'Angle View' and displays a 2x2 grid of spot images. The text '4 incidents' is overlaid on the grid. To the right of the grid, there are several data fields:

- Tilt Angle Intensity Centroid**
 - Angle X: -0.2488 [deg]
 - Angle Y: 0.0363 [deg]
 - Angle D: 0.2514 [deg]
- Beam Divergence**
 - D4Sigma: 40.4051 [mrad]
 - D4Sigma X: 40.0697 [mrad]
 - D4Sigma Y: 40.7377 [mrad]
 - D86: 37.4244 [mrad]
- Beam Ellipticity**
 - Ellipticity m/M: -
- Judgement**
 - Tilt Angle (D):
 - Beam Divergence:
 - Beam Ellipticity:

At the bottom left, there are power and count statistics:

- Frame Rate: 4.3 [fps]
- Total Count: 27148.0 [-]
- Peak: 12.0 [-]

At the bottom right, there is a 'Main Spot' dropdown menu set to '1' and a table of measurement results for 4 spots:

No.	Angle X	Angle Y	A
1	-0.2488	0.0363	
2	-0.2334	-0.6836	
3	0.3464	-0.0292	
4	-0.2423	0.0422	

Two callout boxes provide additional information:

- By changing "Number", the corresponding Number (No.) in the list below can be displayed in the Title Angle at the top.
- Displays the measurement results of 4 spots on the measurement results screen. The list is automatically updated with the number of detected beams.

Setting method

To enter the number of measuring spots to be displayed

Changing "Spot Count" enables the number displayed on the measurement results screen to be designated.

Change "Spot Count" in option settings.

Multi Spot

Order Area

Spot Count 2 [-]

Min Spot Area 64

Suruga OptGauge - ProCo - ProCo Ver.0.0.6 64bit - Debug

Option (O)

SURUGA SEIKI

Angle View

Tilt Angle Intensity Centroid

Angle X -0.2488 [deg]

Angle Y 0.0363 [deg]

Angle D 0.2514 [deg]

Beam Divergence

D4Sigma 40.4051 [mrad]

D4Sigma X 40.0697 [mrad]

D4Sigma Y 40.7377 [mrad]

D86 37.4244 [mrad]

Beam Ellipticity

Ellipticity m/M -

Judgement

Tilt Angle (D)

Beam Divergence

Beam Ellipticity

Main Spot

Number 1

No.	Angle X	Angle Y	A
1	-0.2488	0.0361	
2	-0.2434	0.0421	

X: --- Y: --- 1040 x 1040

Frame Rate 4.3 [fps]

Power

Total Count 27148.0 [-]

Peak 12.0 [-]

Adaptive Cal

To enter the conditions (size) of the beams to be detected as measurement targets

Changing "Min Spot Area" enables the conditions of the beams to be detected as measurement targets to be designated.

Change "Min Spot Area" in option settings.

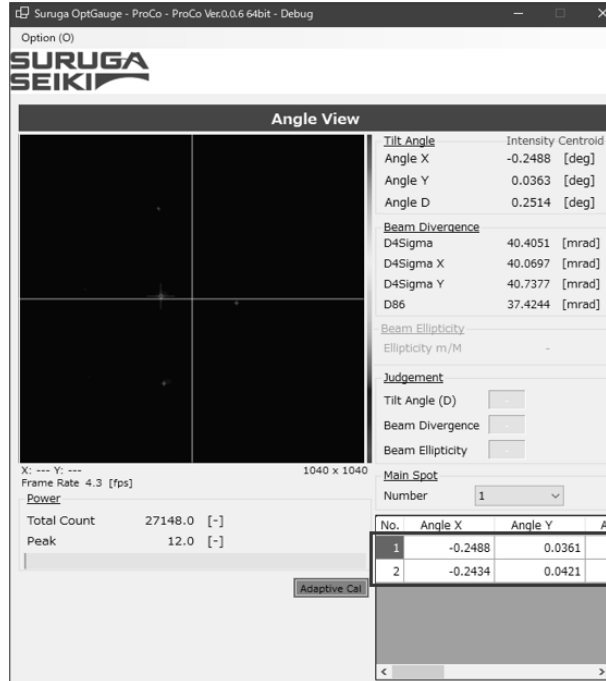
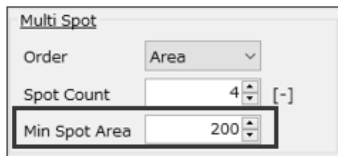

Info

Use pixels for the values set for beam conditions. The setting example detects beam areas of 200 pix or higher received by the camera as measurement targets.

3.4 Names and Functions of Option Screen Components

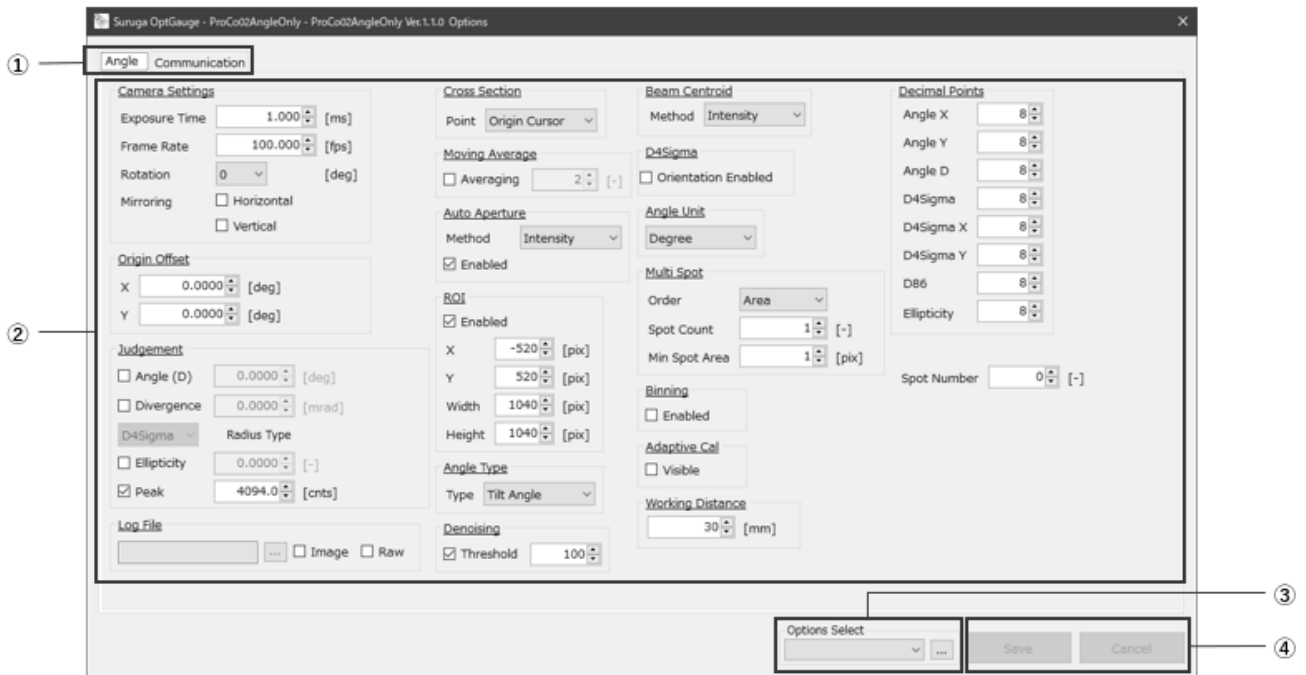

OptGauge Option Screen

① Option Tab	Select the tab to display options.
② Settings	Measurement conditions can be changed.
③ Option Select	An option list can be created for operation while switching. See ("Option List")
④ Save/Cancel	Button is enabled when option contents are changed. Click the Save button after settings changes to save the changes. To cancel settings changes, click the Cancel button.

3.4.1 Measurement Option Setting Details

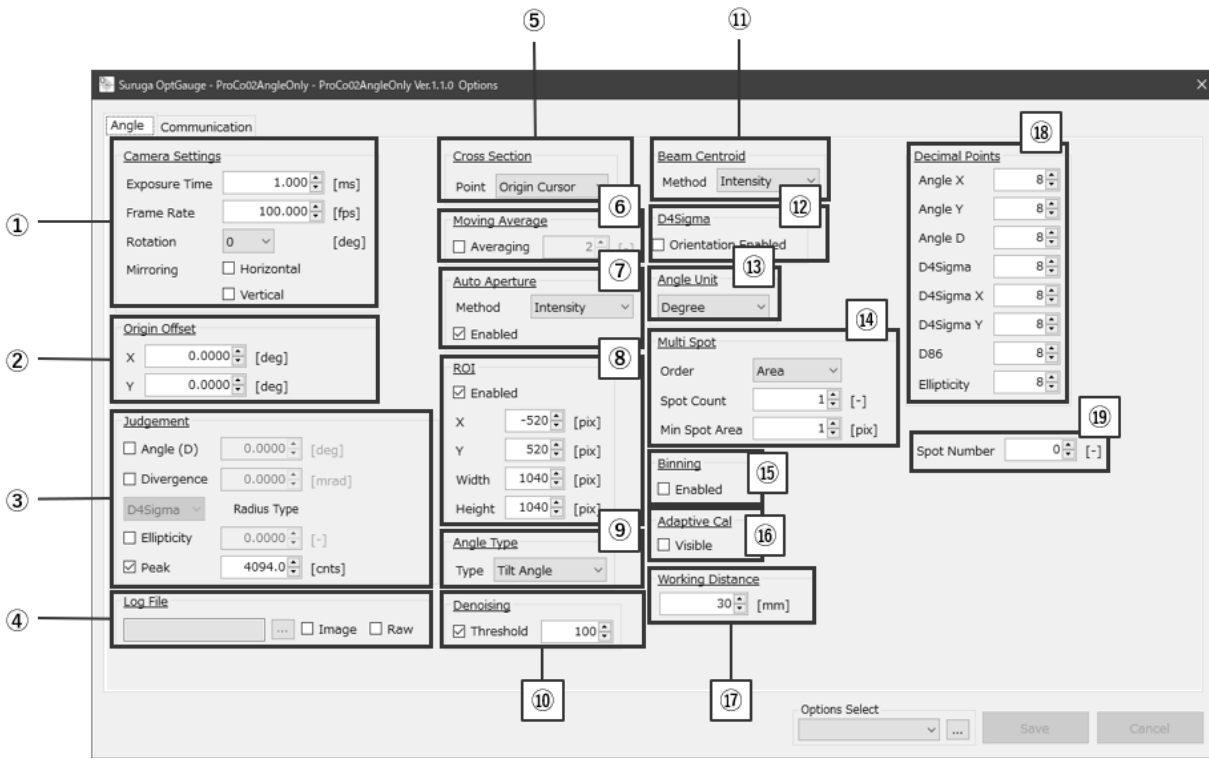

① Camera Settings			
Exposure Time	Sets the sensor camera exposure time. (def. = 1.0) Setting range: 0.027 to 2000		
Frame Rate	Sets the sensor camera frame rate. (def. = 5.0) Setting range: 0.1 to 100		
Rotation	Sets image rotation.		
	0 (def.)	No Rotation.	
	90	Rotate 90° clockwise with the center of the sensor camera as the origin.	
	180	Rotate 180° clockwise with the center of the sensor camera as the origin.	
Mirroring	270	Rotate 270° clockwise with the center of the sensor camera as the origin.	
	Horizontal	Vertical	Sets mirroring
	Disabled (def.)	Disabled (def.)	No mirroring
	Enabled	Disabled	Horizontal mirroring
	Disabled	Enabled	Vertical mirroring
Enabled	Enabled	Vertical and horizontal mirroring	

② Origin Offset	Offsets coordinate center position (white cross). *See "Origin Offset" in the Function Details	
	X	With the sensor camera center as "0.0000 (def.)", adjusts (offsets) white cross position in X direction. Setting range: -20.0000 to 20.0000
	Y	With sensor camera center as "0.0000 (def.)", adjusts (offsets) cross (white) position in Y direction. Setting range: -20.0000 to 20.0000
③ Judgement Settings		
Angle	Sets the Angle (D) OK/NG judgement for the Tilt Angle or Beam Angle. Setting range: 0.0000 to 20.0000 (def. 0.0000) *See "Judgement" in the Function Details	
	Enabled	Enables the Judgement.
	Disabled (def.)	Disables the Judgement.
Divergence	Sets the D4Sigma or D86 OK/NG judgement for beam divergence. Setting range: 0.0000 to 1,000.0000 (def. 0.0000) *See "Judgement" in the Function Details	
	Enabled	Enables the Judgement.
	Disabled (def.)	Disables the Judgement.
Radius Type	D4 Sigma	Sets D4 Sigma for the divergence to be judged.
	D86	Sets D86 for the divergence to be judged.
Ellipticity	Sets the ellipticity OK/NG judgement for beam ellipticity. Setting range: 0.0000 to 1.0000 (def. 0.0000) *See "Judgement" in the Function Details	
	Enabled	Enables the Judgement.
	Disabled (def.)	Disables the Judgement.
Peak	Sets the Peak OK/NG judgement for the Power. Setting range: 0.0 to 4095.0 (def. 4094.0) *See "Judgement" in the Function Details	
	Enabled	Enables the Judgement.
	Disabled (def.)	Disables the Judgement.
④ Log File		
	To specify outputs where to save the measurement results (CSV).	

Image	Enabled	Outputs image data at the Angle View (.png) along with the measurement results (.csv).
	Disabled (def.)	Does not output Angle View image data (PNG)
Raw	Enabled	Outputs Angle View raw image data (CSV)* with measurement results (CSV) * Outputs luminance values per pixel
	Disabled	Does not output Angle View raw image data (PNG)
⑤ Cross Section	Sets the sectional view display location.	
	Origin Cursor	Displays coordinate center position beam strength distribution.
	Beam Cursor	Displays the centroid of a beam strength distribution.
⑥ Moving Average	Sets averaging process (moving average) for measurement values. Setting range: 2 to 262,144 (def. = 2)	
	Enabled	Enables the averaging process.
	Disabled (def.)	Disables the averaging process.
⑦ Auto Aperture	Sets the Auto Aperture. *See "Aperture" in the Function Details	
	Enabled	Enables the Auto Aperture setting.
	Disabled (def.)	Disables the Auto Aperture setting.
	Area	Sets Auto Aperture from the centroid position calculated with the Area Centroid process.
	Intensity (def.)	Sets Auto Aperture from centroid position calculated with intensity weighed process.
⑧ ROI	Sets ROI. *See "Aperture" in the Function Details	
	Enabled	Enables ROI setting
	Disabled (def.)	Disables ROI setting
	X	Sets ROI X direction setting position. Range: -3,000 to 3,000 (def. = 0)
	Y	Sets ROI Y direction setting position. Range: -3,000 to 3,000 (def. = 0)
	Width	Sets ROI horizontal width. Setting range: 0 to 3,000 (def. = 0)
	Height	Sets ROI vertical width. Setting range: 0 to 3,000 (def. = 0)

⑨ Angle Type	Sets targets for the angle measurement	
	Tilt Angle (def.)	Sets for the reflection angle measurement. Sets 1/2 of an incident beam as the measured target angle.
	Beam Angle	Sets for the external light angle measurement. Sets the incoming beam angle as the measurement target angle.

⑩ Denoising	Sets thresholds. When enabled, it derives the measurement values using the pixels of the pixel values higher than the set value. Setting range: 1 to 4,095 (def. = 100)	
	Enabled	Enables denoising setting.
	Disabled	Disables denoising setting.

⑪ Beam Centroid	Sets the calculation method for the Centroid position of a light beam.	
	Area	Calculates the centroid position with the Area of Centroid process.
	Intensity (def.)	Calculates the centroid position with the intensity weighing process.

⑫ D4Sigma

Orientation Enabled	Switches "Beam Divergence" measurement content and "Beam Ellipticity" enabled/disabled.	
	Enabled	<ul style="list-style-type: none"> Displays D4 Sigma M (major) and D4 Sigma m (minor) beam divergence. Enables beam ellipticity.
	Disabled (def.)	<ul style="list-style-type: none"> Displays D4 Sigma X and D4 Sigma Y beam divergence. Disables beam ellipticity.

⑬ Angle Unit	Sets the angle unit for measurement values.	
	Degree (def.)	Sets for decimal degree unit.
	DegMinSec	Sets for degrees-minutes-seconds unit.
	Milliradian	Sets for milli radian unit.

⑭ Multi Spot *See "Multi Spot" in the Function Details

Order	Sets the sorting type of the measurement results displayed when detecting multiple beams.	
	Area (def.)	Sorts by beam area from the largest size.
	Angle	Sorts by beam angle from the smallest angle.

Spot Count	Sets the number to be displayed on the measurement results screen when detecting multiple beams. Setting range: 1 to 100 (def. = 1)	
Min Spot Area	Sets the threshold value for the beam size (pixels) conditions of the beam to be detected. Setting range: 1 to 100 (def. = 1)	
⑮ Binning	Sets the Binning function (2x2) of the sensor camera. When binning is "enabled", adjacent pixels are combined to increase the noise sensitivity of the camera. It also improves the frame rate by reducing the image size by 1/4 and reducing the data volume.	
	Enabled	Enables binning function.
	Disabled (def.)	Disables binning function.
⑯ Adaptive Cal	Sets "Adaptive Cal" button show/hide.	
	Enabled	Shows the "Adaptive Cal" button.
	Disabled (def.)	Hides the "Adaptive Cal" button.
⑰ Working Distance	Designates the measurement distance to the measurement target. Designation enables measurement results with guaranteed linearity. Setting range: 30 to 300 (def. = 30)	
⑱ Decimal Points	Designates the number of decimal places when outputting measurement results. Setting range: 0 to 8 (def. = 8) *Measurement results output indicates the results (.csv) output with the [Output Once] button and the output from communication controlled from external devices.	
	Angle X	Sets the number of decimal places for Angle X measurement results output.
	Angle Y	Sets the number of decimal places for Angle Y measurement results output.
	Angle D	Sets the number of decimal places for Angle D measurement results output.
	D4Sigma	Sets the number of decimal places for D4Sigma measurement results output.
	D4SigmaX(M)	Sets the number of decimal places for D4SigmaX(M) measurement results output.
D4SigmaY(m)	Sets the number of decimal places for D4SigmaY(m) measurement results output.	

	D86	Sets the number of decimal places for D86 measurement results output.
	Ellipticity	Sets the number of decimal places for ellipticity measurement results output.
①⁹ Display		
Spot Number	<p>Sets the maximum number of beam numbers to be displayed in the Angle view.</p> <p>The numbers are sorted according to "Order" of "Multi Spot".</p> <p>Setting range: 00 to 100 (def.= 0)</p>	

3.5 Option List

This software can store multiple option lists and switching among them.

If you want to apply different option settings to different measurement objects or different measurement wavelengths, you can switch option lists while the application is running.

This chapter explains how to switch, register, and delete multiple option lists.

3.5.1 Switching Option Lists

This section explains how to switch option lists.

1. From the "Options Select" pulldown menu, select the desired option list name.
2. Click the "Save" button.

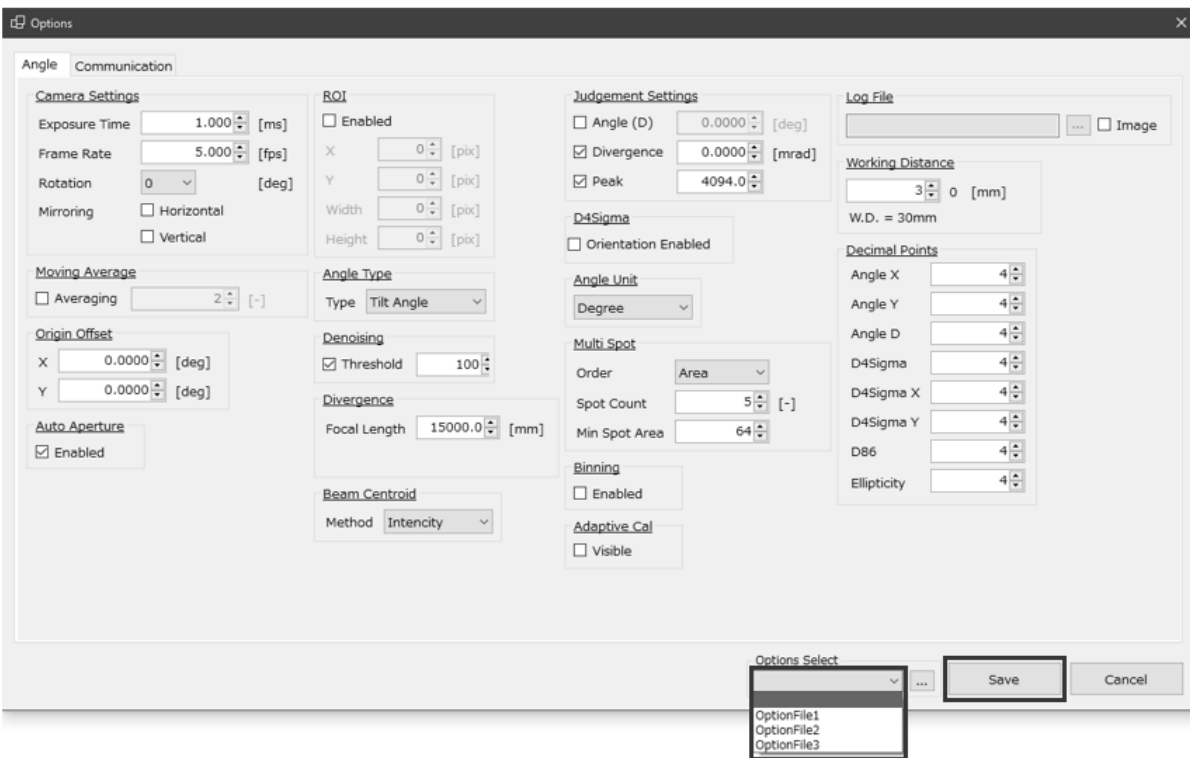

3.5.2 Registering Option Lists

This section explains how to register option lists. Up to 31 option lists can be registered.

1. Click the [...] button.
2. Enter an arbitrary option name and click the [Add] button.

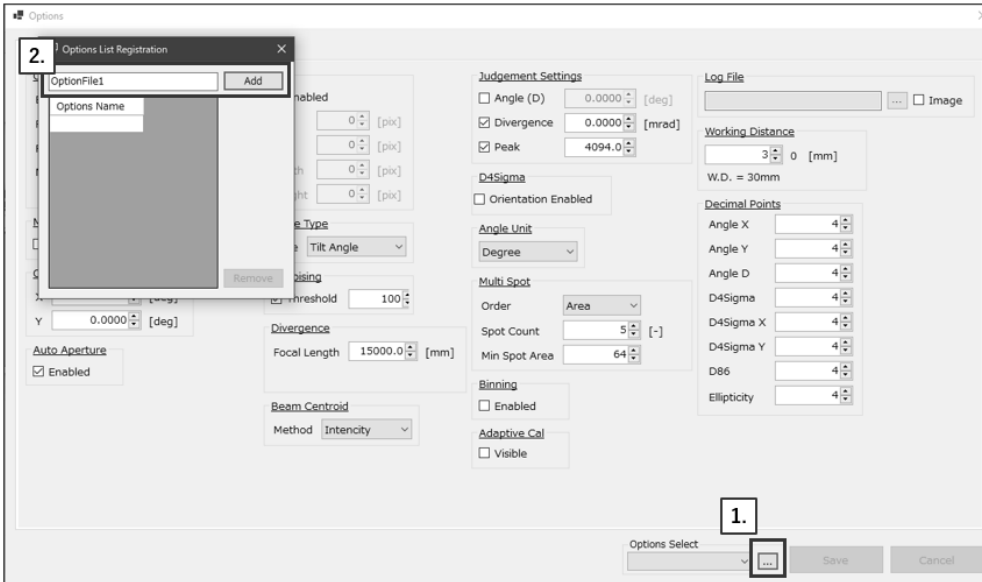

3. Click the [X] button.
4. Click the [Save] button.

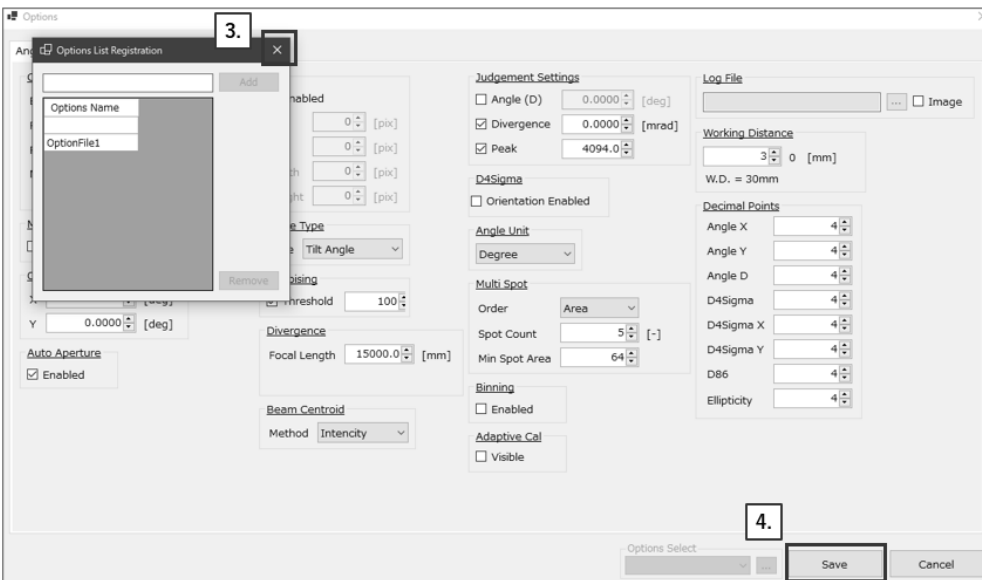

5. The list is now registered in "Options Select" for selection. (*See "Switching Option Lists")

3.5.3 Deleting Option Lists

This section explains how to delete option lists.

1. Select all but the option name to be deleted and click the [...] button.
2. Select the option name to be deleted and click the [Remove] button.

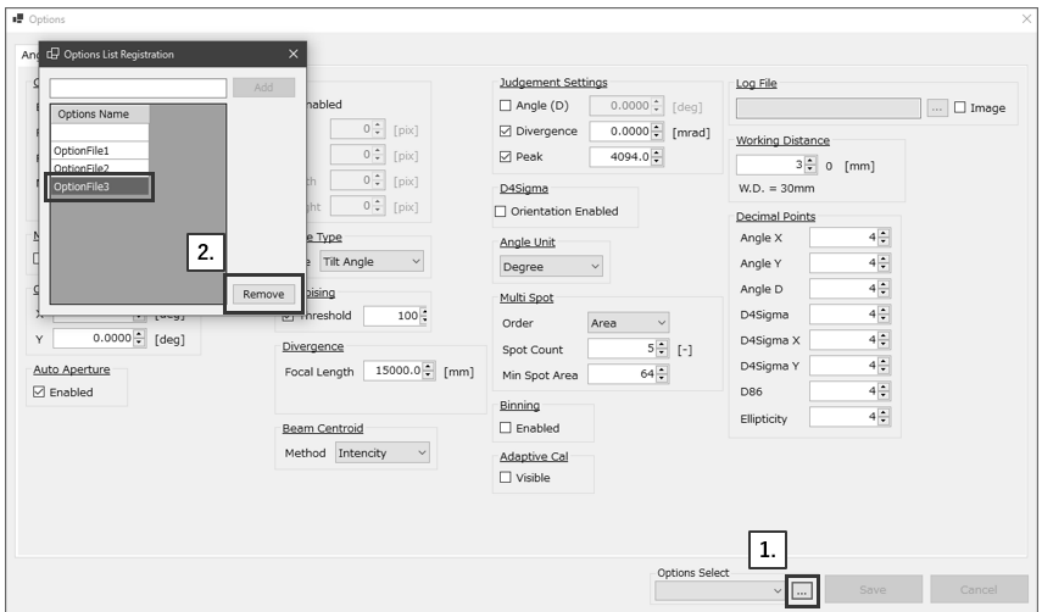

3. Click the [X] button.
4. Click the [Save] button.

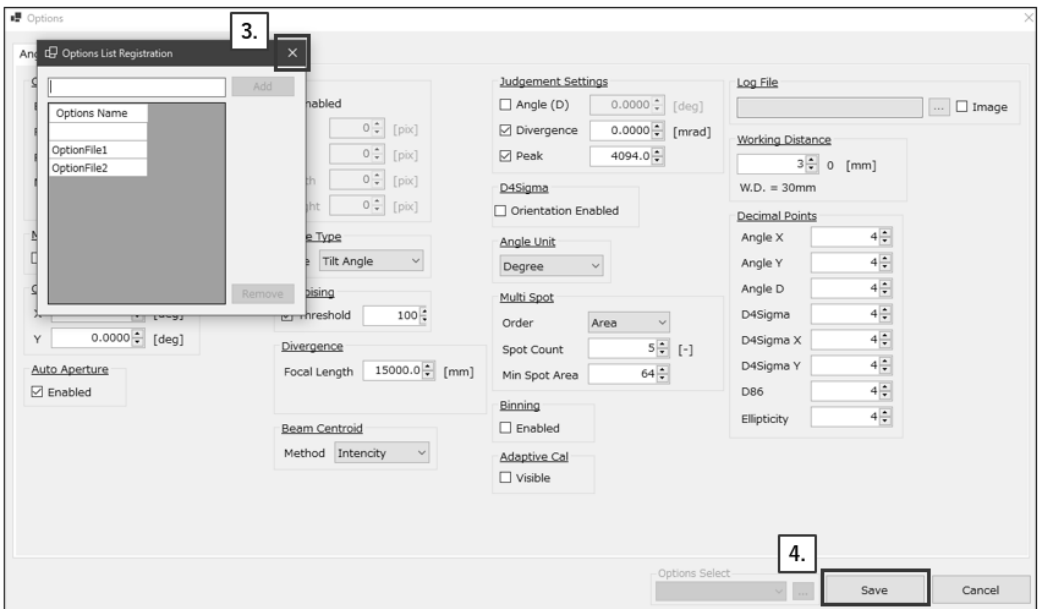

4. Measuring

4.1. Overview of Measurement Methods

4.1.1. Angle measurement using the reflection angle measurement

See **the reflection angle measurement** in "Tilt Angle/Beam Angle" in the Function Details.

4.1.2. Angle measurement using the external light angle measurement

See **the external light angle measurement** "Tilt Angle/Beam Angle" in the Function Details.

4.1.3. Beam divergence measurement

See "Beam Divergence" in the Function Details

4.1.4. Multi Spot measurement

See "Multi Spot" in the Function Details

5. Controlling from External Devices

The Products can send and receive data through command communication with external devices via serial communication (or TCP/IP communication).

5.1. RS232C

There are two general patterns of RS232C connection. After connection, serial communication is used to send and receive data through terminal software* which exchanges commands with OptGauge.

*The customer is asked to provide their own terminal software.

5.1.1. Communication Specifications

Item	Content
Synchronization method	Asynchronous
Transmission code	UTF-8
Data type	8 bits
Stop bit	1 bit
Parity	None
Flow control	None
Baud rate (bps)	9600 / 19200 / 38400 / 57600 / 115200

5.1.2. The Connections Illustrated

Using external devices for communication

1. Set up two computers and connect with an RS232C cable.
2. Connect this product to one of the computers, launch OptGauge, and start measurement.
3. Prepare terminal software on the other computer.
4. Set the communication settings for the command and begin communication.

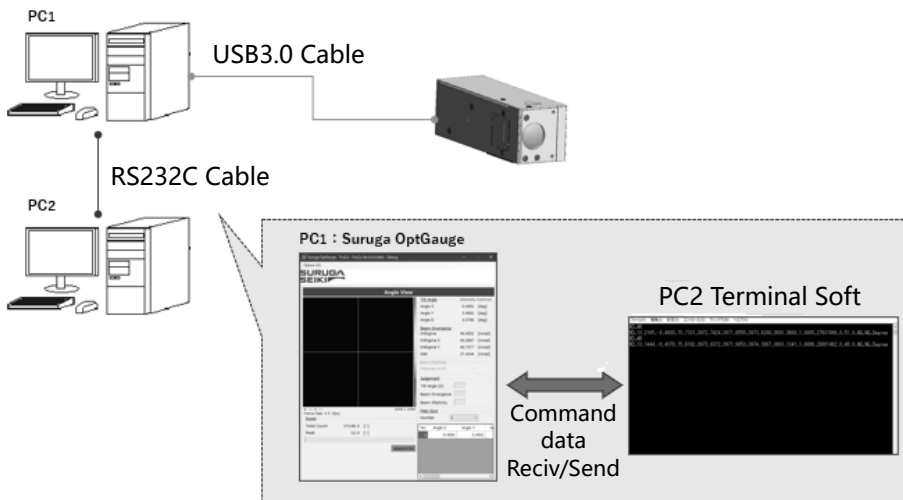

Using the same computer for communication

1. Connect this product to one computer and then connect the RS232C cable to your own computer.
2. Launch OptGauge and start measurement.
3. Prepare terminal software on the computer.
4. Set the communication settings for the command and begin communication.

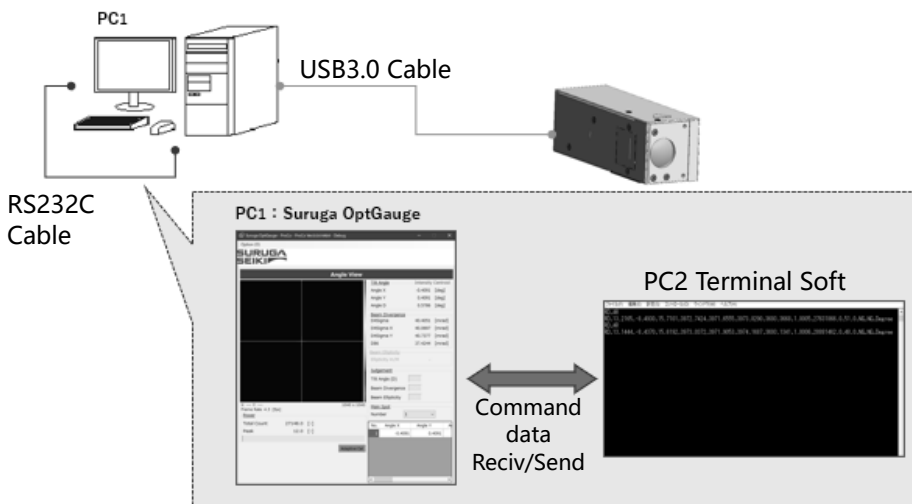

5.1.3. Command Communication Setting Method

Settings for OptGauge and terminal software to conduct command communication are indicated here.

Suruga OptGauge

1. Select the [Communication] tab in option settings.
 2. Set the "Interface" to "COM" at the Communication Type.
 3. Set "Port" and "Baud Rate" (arbitrary) in the COM settings.
- ※ "Port" automatically displays the connected port candidates when RS232C is connected.



Terminal Software

The terminal software, to be provided by the customer, is to be set as below.

1. Set the COM port which matches the "Port" setting in OptGauge.
2. Set the same baud rate as the "Baud Rate" setting in OptGauge.
3. For settings other than the above, see the "Communication Specifications."

5.2. TCP/IP

Generally, there are three patterns of TCP/IP connection. After connection established, TCP/IP communication is used to send and receive data through terminal software* which exchanges commands with OptGauge.

*The customer is asked to provide their own terminal software.

5.2.1. Communication Specifications

Item	Details
Protocol	TCP
IPv4 address	See "Command communication setting method"
Subnet mask	
Default gateway	
DNS server address	
Port number	Private port (49152-65535) range

5.2.2. Image of Connection

Using external devices for communication: Ethernet cable

1. Set up two computers and connect them with an Ethernet cable.
2. Connect this product to one of the computers, launch OptGauge, and start measurement.
3. Prepare terminal software on the other computer.
4. Set the communication settings for the command and start communication.

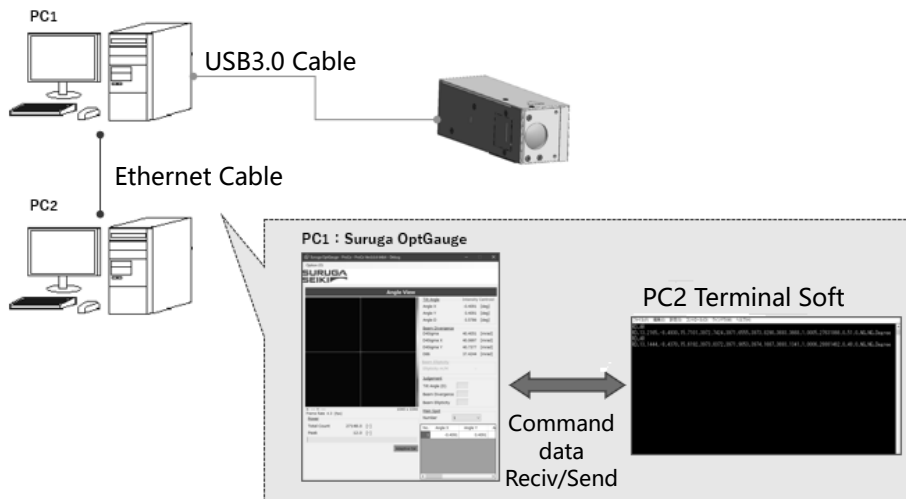

Using external devices for communication: Wireless router

1. Set up two computers and connect with a wireless router.
2. Connect this product to one of the computers, launch OptGauge, and start measurement.
3. Prepare terminal software on the other computer.
4. Set the communication settings for the command and start communication.

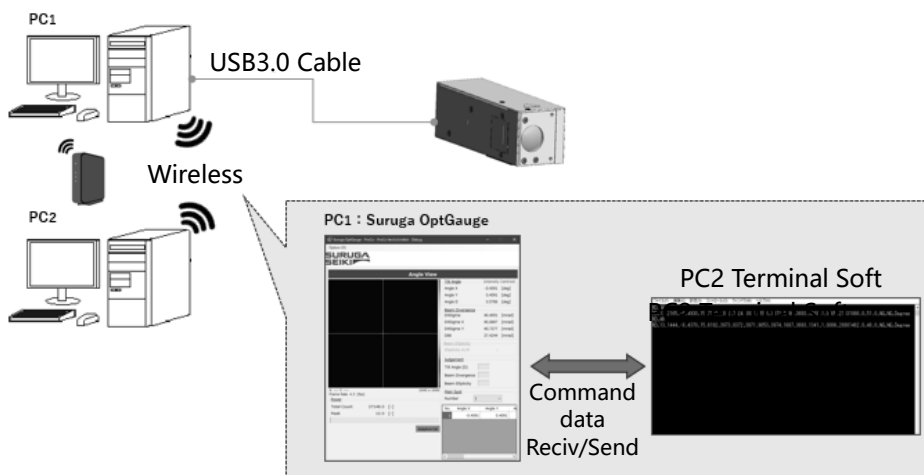

Using the same computer for communication

1. Connect this product to one computer.
(there is nothing to connect, as the local host address is used).
2. Launch OptGauge and start measurement.
3. Prepare terminal software on the computer.
4. Set the communication settings for the command and start communication.

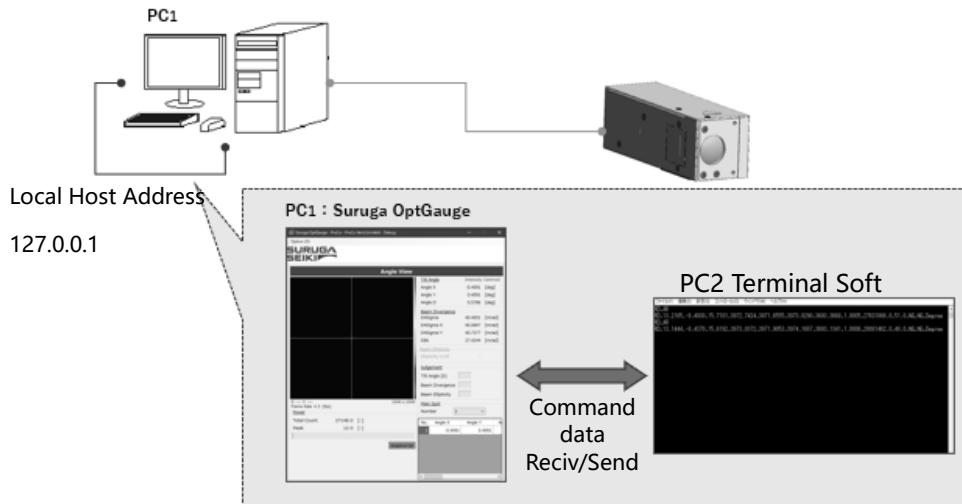

5.2.3. Command Communication Setting Method

Settings for a computer, OptGauge and terminal software to conduct command communication are indicated here.

Using external devices for communication

PC Settings

1. Click the [Start] button on the computer to which this product is connected and select [Settings] from the start menu.

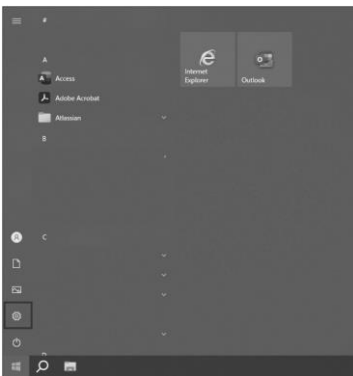

2. Click [Network and Internet] and select [Change adapter options].

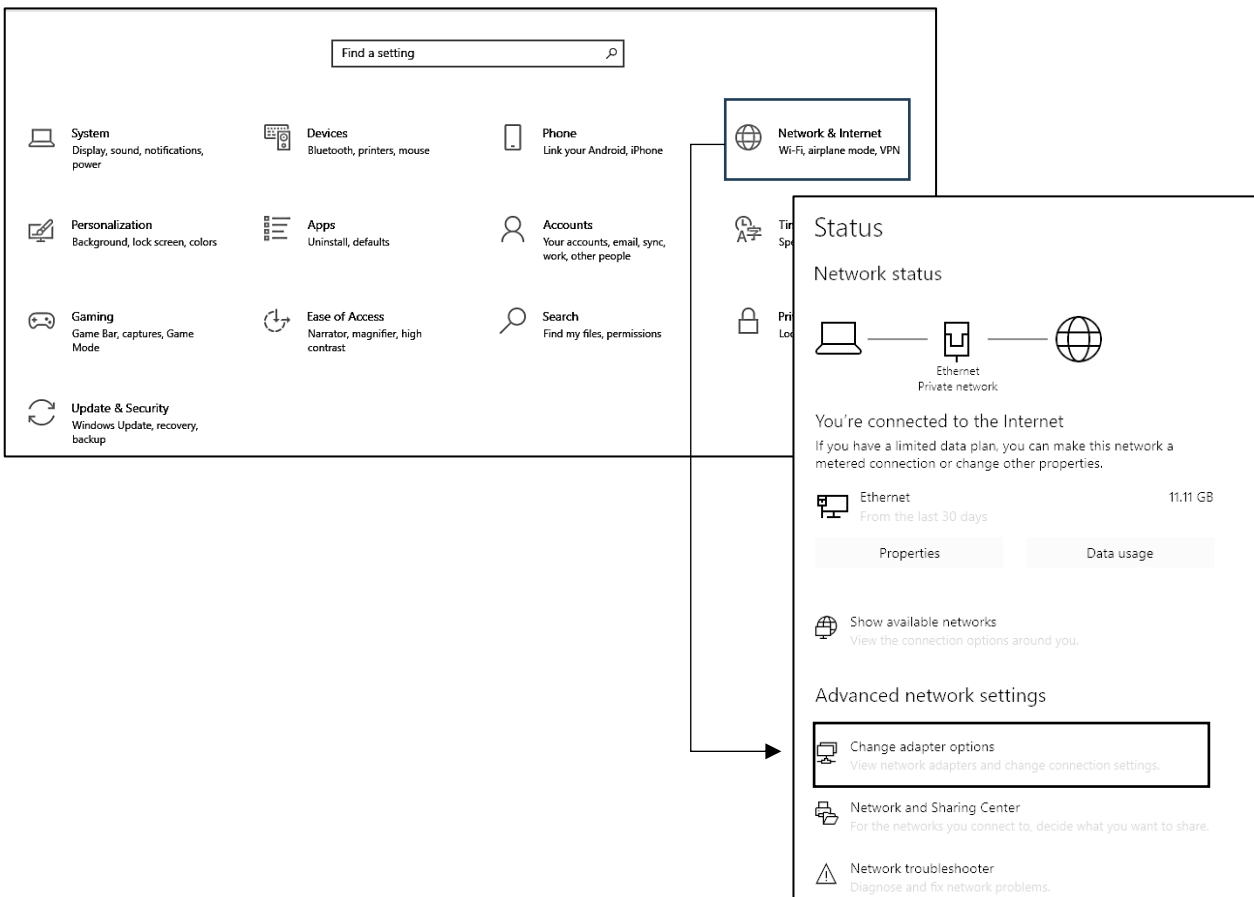

3. Select Wi-Fi, if using a wireless router, or right-click Ethernet and select “Properties” if using an Ethernet cable.

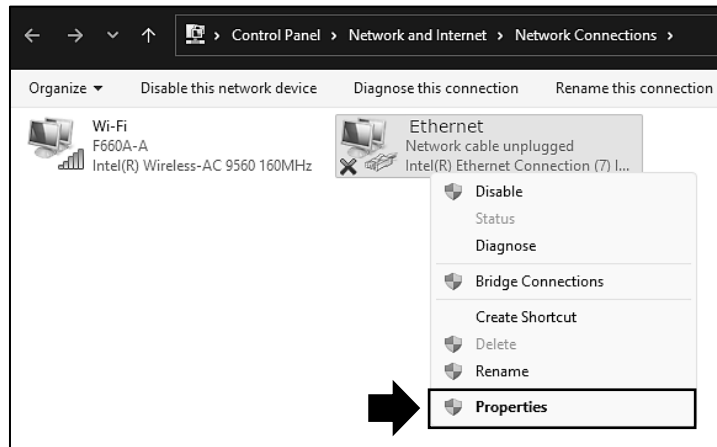

4. Click Internet Protocol Version 4 (TCP/IPv4) and select [Properties].

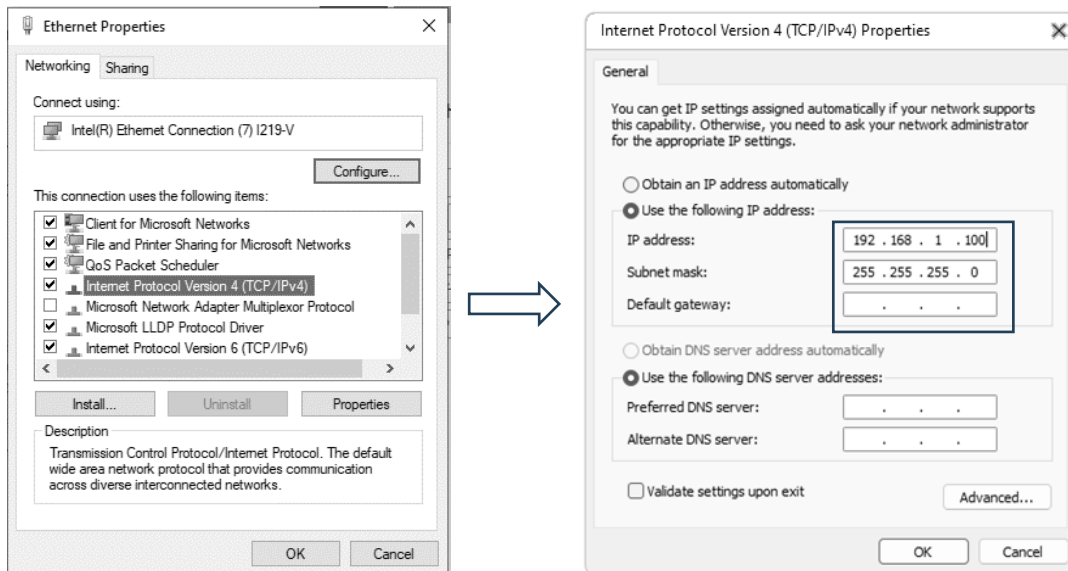

5. Select [Use the following IP address:] and enter [IP address:] and [Subnet mask:].

Ex. IP address: 192.168.1.100

Subnet mask: 255.255.255.0

Default gateway: (no input required)

6. Select [Use the following DNS server addresses:] (no input required).

7. Click [OK].

8. Follow steps 1 to 7 of this procedure for the other computer.

However, do as follows to make sure that in step 5 the IP address settings are not duplicated.

Ex. IP address: 192.168.1.**101** (*change only the last number)

Subnet mask: 255.255.255.0

Default gateway: (no input required)

Suruga OptGauge

1. Select the [Communication] tab in option settings.
2. Set "Communication Type - Interface" to "TCP/IP".
3. Set "Port" (arbitrary) in TCP/IP settings.



Terminal Software

The terminal software, to be provided by the customer, is to be set as below.

- Designate the IP address set on the computer to which the sensor head is connected, in "Computer settings - When using external devices for communication," as the connection destination.
- Set the TCP port which matches the "Port" setting in OptGauge.

*This is the minimum setting required for command communication using TCP/IP communication.

For network communication

The customer is prompted to set as needed with consideration for applications such as security.

Using the same computer for communication

OptGauge

1. Select the [Communication] tab in option settings.
2. Set "Communication Type - Interface" to "TCP/IP".
3. Set "Port" (arbitrary) in TCP/IP settings.



Terminal Software

The terminal software, to be provided by the customer, is to be set as below.

- Local host address: Set **127.0.0.1**
- Set the TCP port which matches the "Port" setting in OptGauge.

5.3. List of Commands

5.3.1. List of Read Commands

[Read Commands]

Command Type	Command Parameter	Command Parameter 1	Commands	
RD	VS		Reads version information	
	OL		Reads option list information	
	AR		Reads measurement results	
	AO	EXT		Reads sensor camera exposure time
		FRA		Reads sensor camera frame rate
		ROT		Reads Rotation setting information
		MHE		Reads Mirroring horizontal setting information
		MVE		Reads Mirroring vertical setting information
		MAV		Reads number of averaging times setting information
		MAE		Reads averaging processing enabled setting information
		CSP		Reads Cross Section Point setting information
		OOX		Reads Origin Offset X value setting information
		OOY		Reads Origin Offset Y value setting information
		AAM		Reads Auto Aperture method setting information
		AAE		Reads Auto Aperture enabled setting information
		ROE		Reads ROI enabled setting information
		RAX		Reads ROI X value setting information
		RAY		Reads ROI Y value setting information
		RAW		Reads ROI width setting information
		RAH		Reads ROI height setting information
		ANT		Reads Angle Type setting information
		AJE		Reads Judgement Angle enabled setting information
		AJV		Reads Judgement Angle Judgement value setting information
DJE		Reads Judgement Divergence enabled setting information		
DJV		Reads Judgement Divergence Judgement value setting information		
BRT		Reads judgement Radius Type setting information		

Command Type	Command Parameter	Command Parameter 1	Commands
		EJE	Reads Judgement ellipticity enabled setting information
		EJV	Reads Judgement ellipticity judgement value setting information

Command Type	Command Parameter	Command Parameter 1	Commands
RD	AO	PJE	Reads judgement peak enabled setting information
		PJV	Reads judgement peak judgement value setting information
		CNM	Reads beam centroid setting information
		ANU	Reads angle unit setting information
		DNE	Reads denoising enabled setting information
		DNT	Reads denoising threshold value setting information
		DAX	Reads angle X decimal place setting information
		DAY	Reads angle Y decimal place setting information
		DAD	Reads angle D decimal place setting information
		DDS	(Beam divergence) Reads D4Sigma decimal place setting information
		DDX	(Beam divergence) Reads D4Sigma X(M) decimal place setting information
		DDY	(Beam divergence) Reads D4Sigma Y(m) decimal place setting information
		DD8	(Beam divergence) Reads D86 decimal place setting information
		DEL	Reads ellipticity decimal place setting information
		MSO	(Multi Spot) Reads order setting information
		MSC	(Multi Spot) Reads spot count setting information
MSM	(Multi Spot) Reads minimum spot area setting information		
ACE	Reads "Adaptive Cal" execute button display enabled setting information		

		DOE	Reads Orientation Enabled setting information
		BIE	Reads Binning enabled setting information
		WDS	Reads Working Distance setting information
		DSN	Reads display spot number setting information

5.3.2. List of Write Commands

[Write Commands]

Command Type	Command Parameter	Command Parameter 1	Commands
WR	AO	EXT	Writes sensor camera Exposure Time
		FRA	Writes sensor camera Frame Rate
		ROT	Writes Rotation setting information
		MHE	Writes Mirroring horizontal setting information
		MVE	Writes Mirroring vertical setting information
		MAV	Writes number of averaging times setting information
		MAE	Writes averaging processing enabled setting information
		CSP	Writes cross section point setting information
		OOX	Writes Origin Offset X value setting information
		OOY	Writes Origin Offset Y value setting information
		AAM	Writes Auto Aperture method setting information
		AAE	Writes Auto Aperture enabled setting information
		ROE	Writes ROI enabled setting information
		RAX	Writes ROI X value setting information
		RAY	Writes ROI Y value setting information
		RAW	Writes ROI width setting information
		RAH	Writes ROI height setting information
		ANT	Writes angle type setting information
		AJE	Writes Judgement Angle enabled setting information
		AJV	Writes Judgement Angle judgement value setting information
DJE	Writes Judgement Divergence enabled setting information		
DJV	Writes Judgement Divergence judgement value setting information		
BRT	Writes Judgement Radius Type setting information		
EJE	Writes Judgement Ellipticity enabled setting information		

Command Type	Command Parameter	Command Parameter 1	Commands
		EJV	Writes Judgement Ellipticity judgement value setting information
		PJE	Writes Judgement Peak enabled setting information
		PJV	Writes Peak Judgement value setting information
		CNM	Writes Beam Centroid setting information
		ANU	Writes Angle Unit setting information

Command Type	Command Parameter	Command Parameter 1	Commands
WR	AO	DNE	Writes Denoising enabled setting information
		DNT	Writes Denoising threshold value setting information
		DAX	Writes Angle X decimal place setting information
		DAY	Writes Angle Y decimal place setting information
		DAD	Writes Angle D decimal place setting information
		DDS	(Beam divergence) Writes D4Sigma decimal place setting information
		DDX	(Beam divergence) Writes D4Sigma X(M) decimal place setting information
		DDY	(Beam divergence) Writes D4Sigma Y(m) decimal place setting information
		DD8	(Beam divergence) Writes D86 decimal place setting information
		DEL	Writes ellipticity decimal place setting information
		MSO	(Multi Spot) Writes Order setting information
		MSC	(Multi Spot) Writes Spot Count setting information
		MSM	(Multi Spot) Writes minimum spot area setting information
		ACE	Writes "Adaptive Cal" execute button display enabled setting information
		DOE	Writes Orientation enabled setting information
		BIE	Writes Binning enabled setting information

Command Type	Command Parameter	Command Parameter 1	Commands
		WDS	Writes working distance setting information
		DSN	Writes Display Spot number setting information

5.3.3. List of Execute Commands

[Execute Commands]

Command Type	Command Parameter	Command Parameter 1	Command content
EX	SV		Executes Option save

5.4. Read Commands

5.4.1. Command Format

[Read version information]

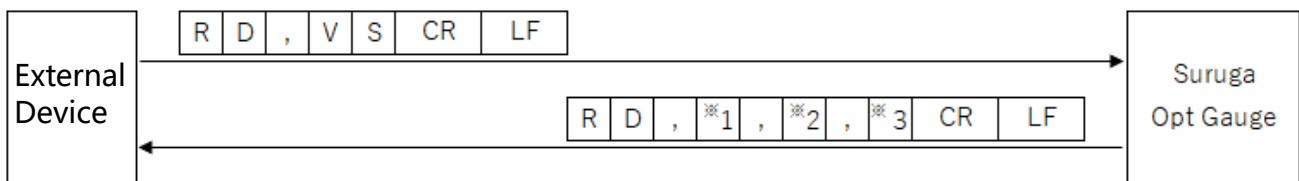

*1: Major number

*2: Minor number

*3: Build number

[Read Option list information]

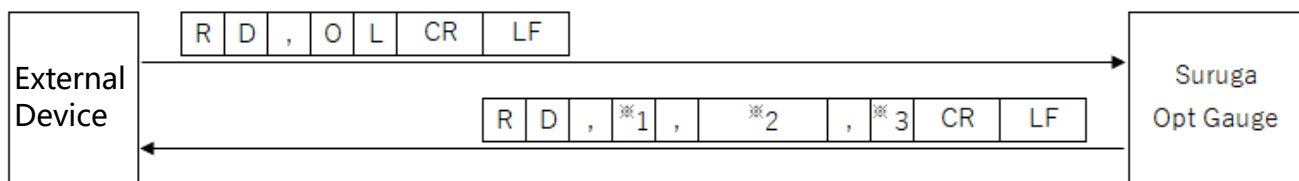

*1: Number of option lists

*2: Option name (includes many option names as there are option lists, separated with commas)

*3: Index indicating selected options

[Read measurement results]

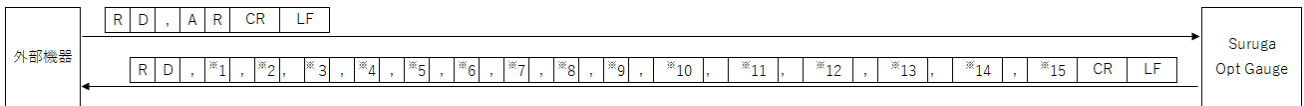

- *1: Tilt Angle/Beam Angle: Angle X measurement value
- *2: Tilt Angle/Beam Angle: Angle Y measurement value
- *3: Tilt Angle/Beam Angle: Angle D measurement value
- *4: Beam Divergence: D4Sigma measurement value
- *5: Beam Divergence: D4Sigma X(M) measurement value
- *6: Beam Divergence: D4Sigma Y (m) measurement value
- *7: Beam Divergence: D86 measurement value
- *8: Beam Ellipticity measurement value
- *9: Beam: Total count value
- *10: Beam: Peak value
- *11: Judgement: Tilt angle (D) judgement result (OK/NG)
- *12: Judgement: Beam divergence judgement result (OK/NG)
- *13: Judgement: Ellipticity judgement result (OK/NG)
- *14: Judgement: Peak judgement result (OK/NG)
- *15: Angle Unit (degree/DegMinSec/milli-radian)

[Read sensor camera exposure time]

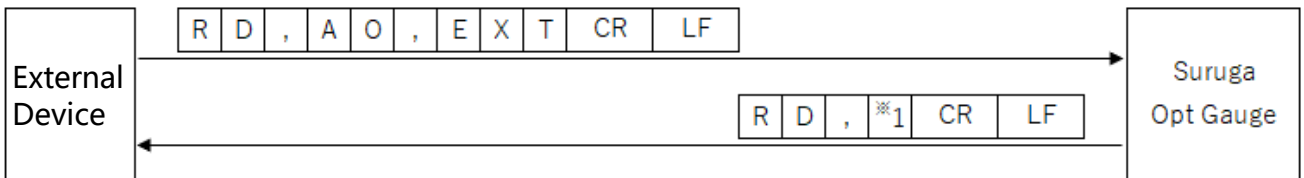

- *1: Exposure time (0.027 to 2000)

[Read sensor camera frame rate]

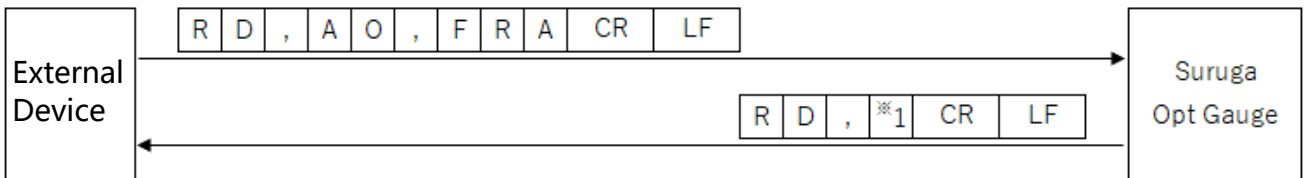

- *1: Frame rate (0.1 to 100)

[Read Rotation setting information]

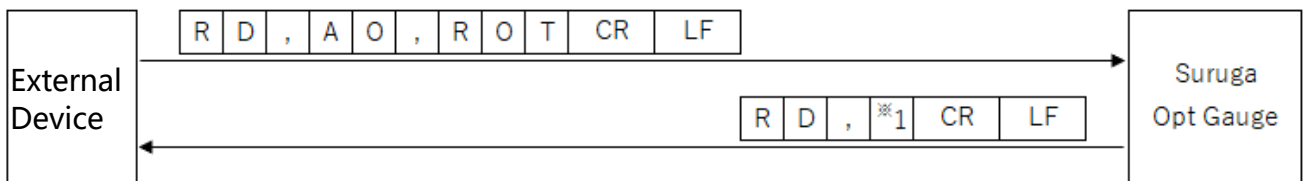

*1: Rotation ("0" = OFF, "1" = Rotation right 90°, "2" = Rotation right 180°, "3" = Rotation right 270°)

c

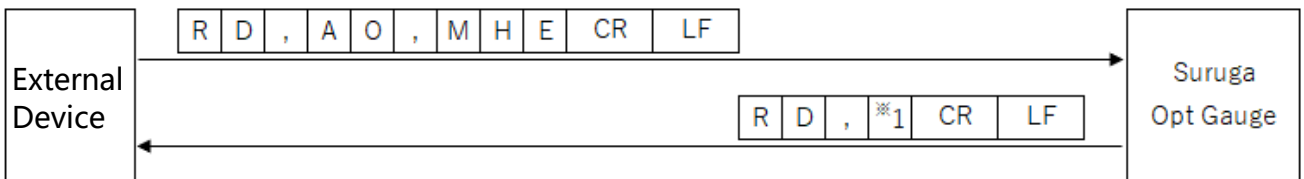

*1: Mirroring ("0" = OFF, "1" = Horizontal Mirroring display)

[Reads Mirroring Vertical setting information]

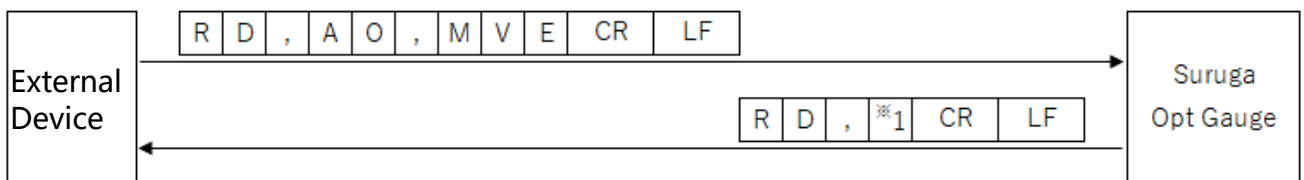

*1: Mirroring ("0" = OFF, "1" = Vertical Mirroring)

[Read Number of Averaging Times setting information]

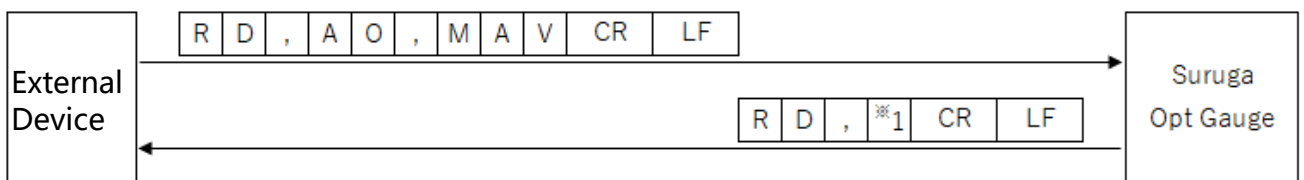

*1: Number of Averaging times (2 to 262,144)

[Read Averaging Processing enabled setting information]

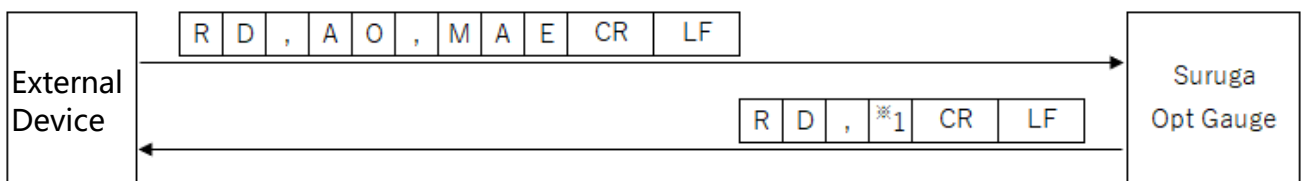

*1: Averaging Processing ("0" = disabled, "1" = enabled)

[Read Cross Section Point setting information]

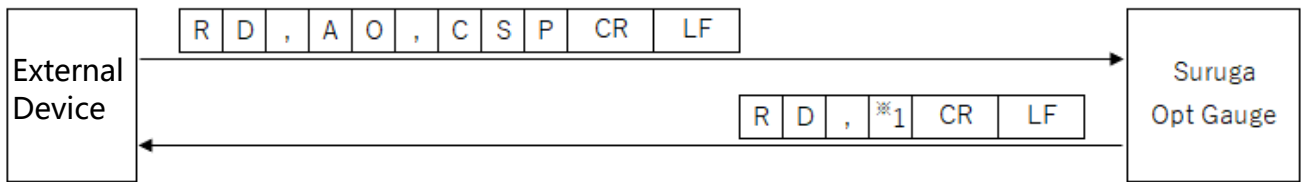

*1: Cross Section Point ("0" = Origin Cursor, "1" = Beam Cursor)

[Read OriginOffset X value setting information]

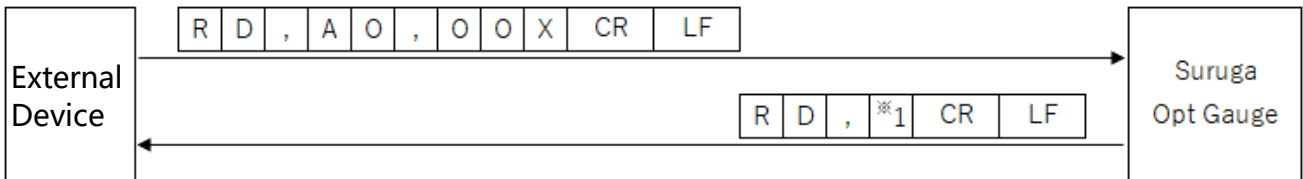

*1: Origin Offset X (-20 to 20)

[Read OriginOffset Y value setting information]

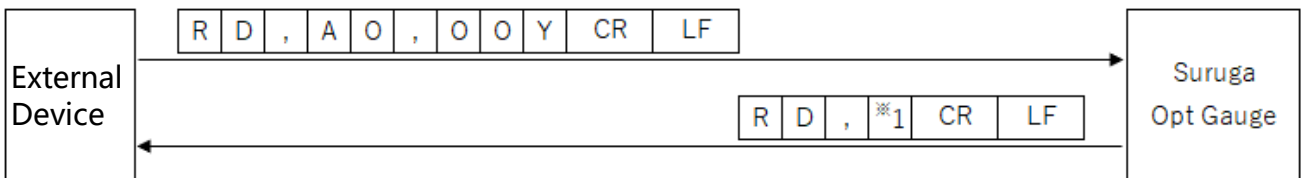

*1: Origin Offset Y (-20 to 20)

[Read Auto Aperture Method setting information]

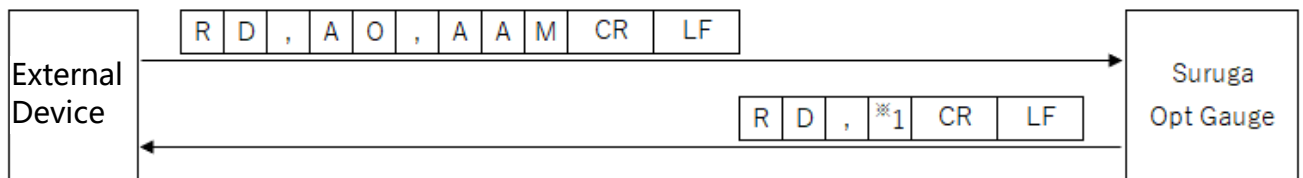

*1: Auto Aperture method ("0" = area, "1" = luminance)

[Read Auto Aperture Enabled setting information]

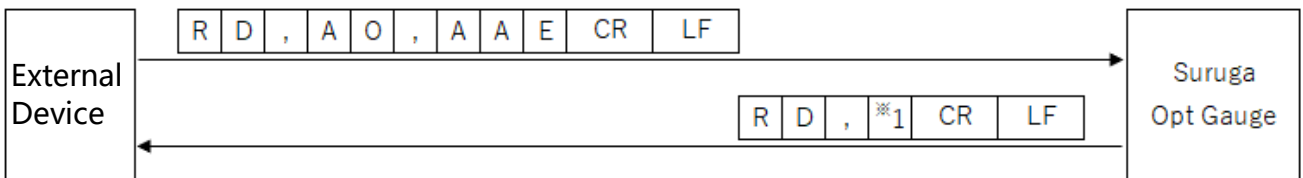

*1: Auto Aperture ("0" = disabled, "1" = enabled)

[Read ROI Enabled setting information]

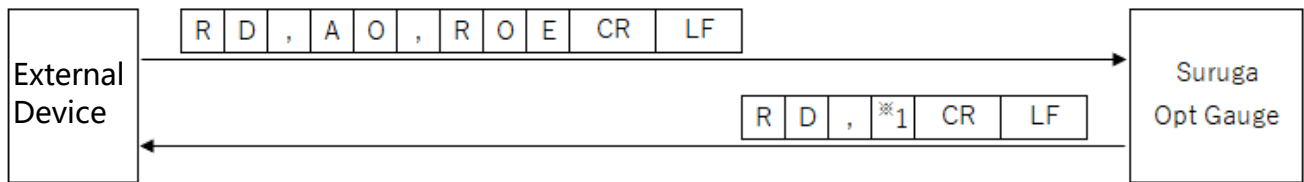

*1: ROI ("0" = disabled, "1" = enabled)

[Read ROI X value setting information]

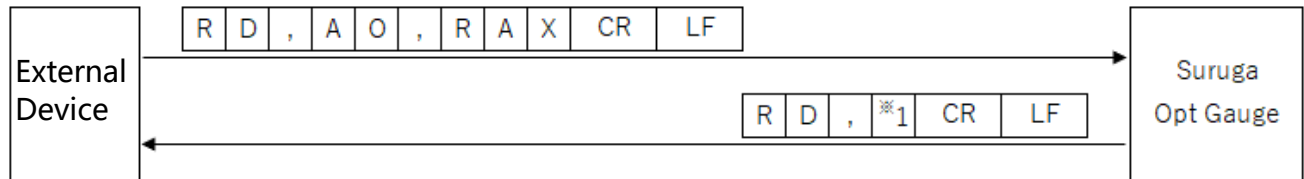

*1: ROI X value (-3,000 to 3,000)

[Read ROI Y value setting information]

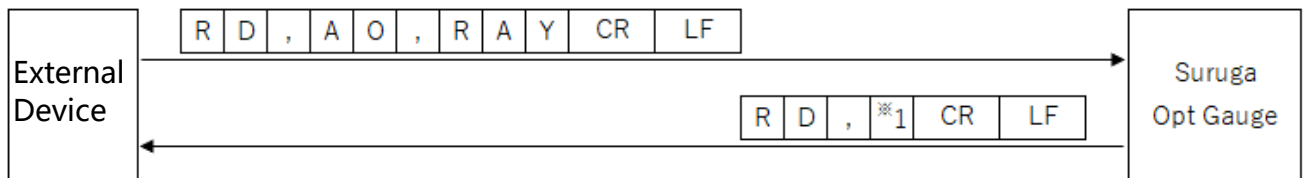

*1: ROI Y value (-3,000 to 3,000)

[Read ROI Width setting information]

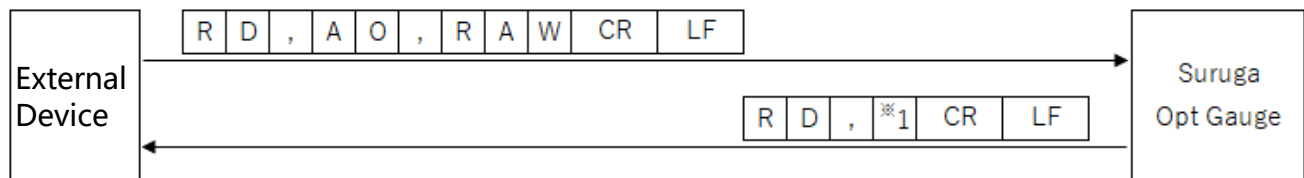

*1: ROI Width (0 to 3,000)

[Read ROI Height setting information]

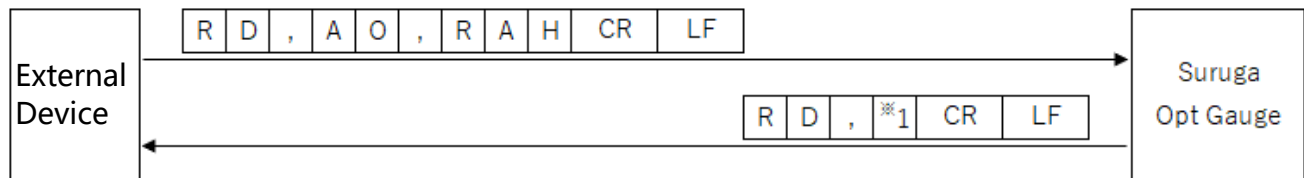

*1: ROI height (0 to 3,000)

[Read Angle Type setting information]

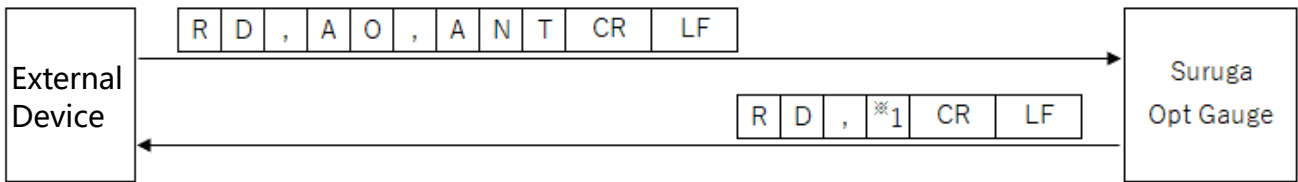

*1: Angle Type ("0" = Tilt Angle, "1" = Beam Angle)

[Read Judgement Angle enabled setting information]

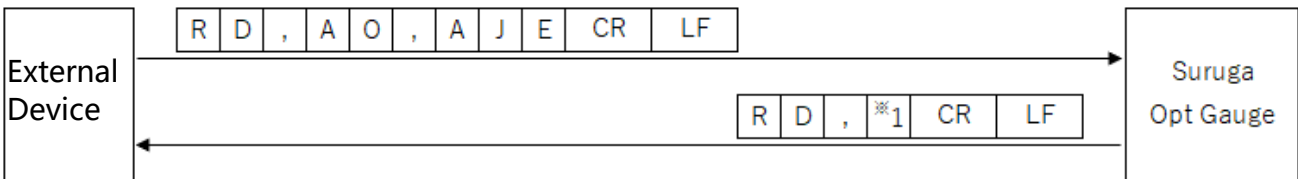

*1: Judgement Angle ("0" = disabled, "1" = enabled)

[Read judgement value setting information at the Judgement Angle]

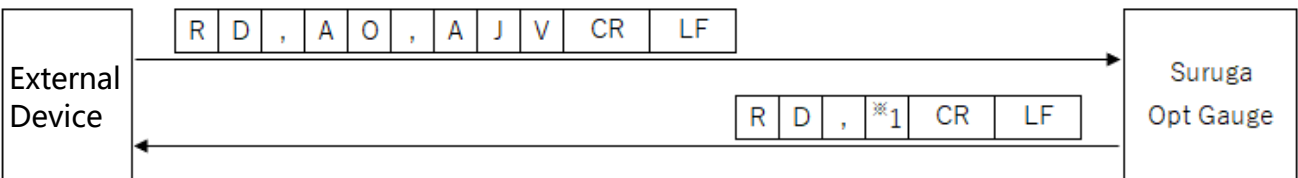

*1: judgement value at the Judgement Angle (0.0000 to 1,000.0000)

[Read Judgement Divergence enabled setting information]

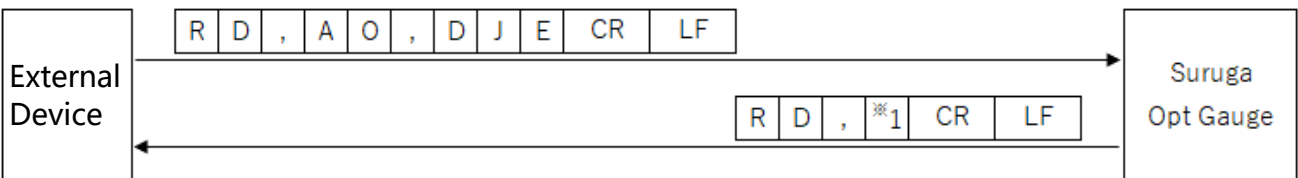

*1: Judgement Divergence ("0" = disabled, "1" = enabled)

[Read judgement value setting information at the Judgement Divergence]

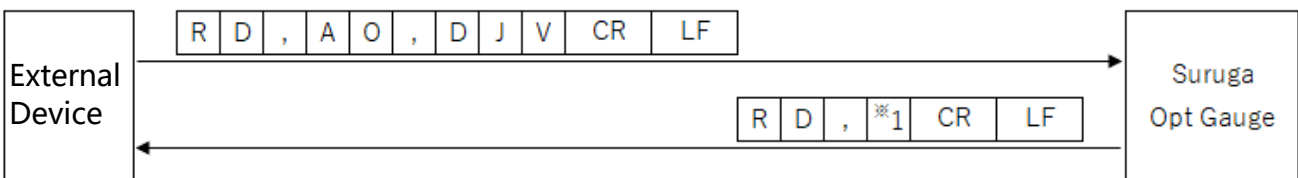

*1: judgement value (0.0000 to 1,000.0000) at the Judgement Divergence

[Read Judgement Radius Type setting information]

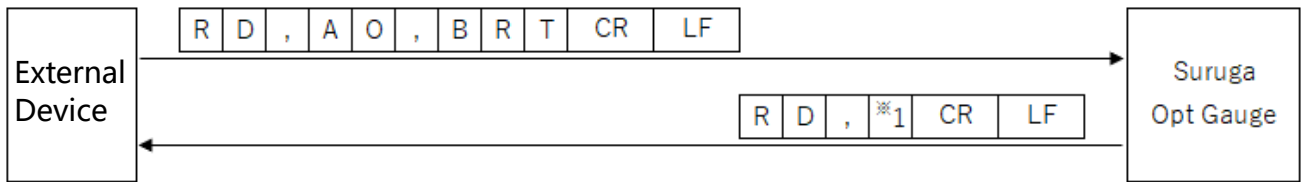

*1: Judgement Radius Type ("0" = D4Sigma, "1" = D86)

[Read Judgement Ellipticity enabled setting information]

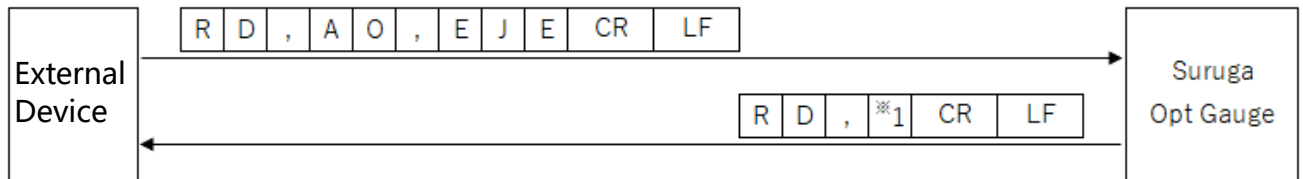

*1: Judgement Ellipticity ("0" = disabled, "1" = enabled)

[Read judgement value setting information at the Judgement Ellipticity]

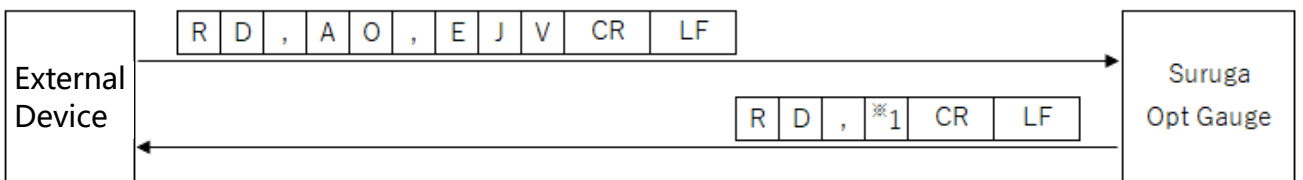

*1: judgement value (0.0000 to 1.0000) at Judgement Ellipticity

[Read Judgement Peak enabled setting information]

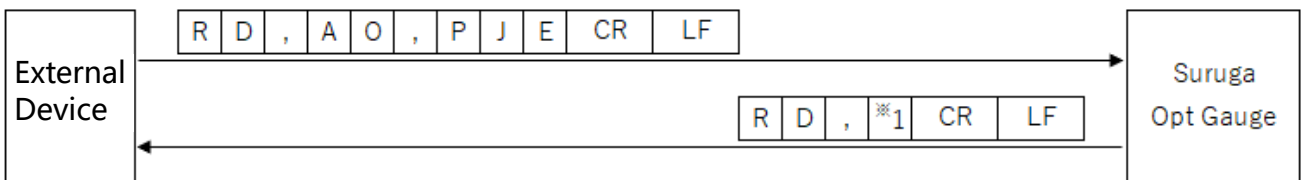

*1: Judgement Peak ("0" = disabled, "1" = enabled)

[Read judgement value setting information at the Judgement Peak]

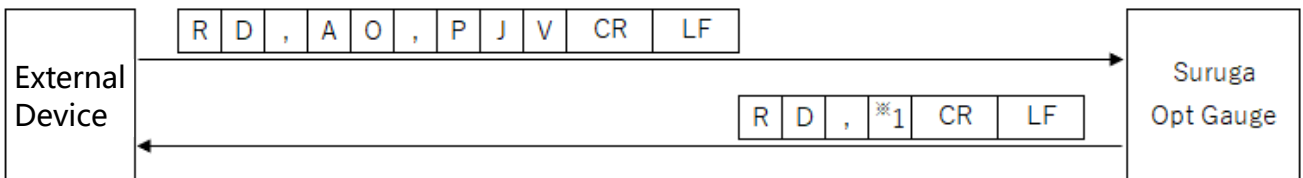

*1: judgement value (0.0 to 4,095.0) at the Judgement Peak

[Read Beam Centroid setting information]

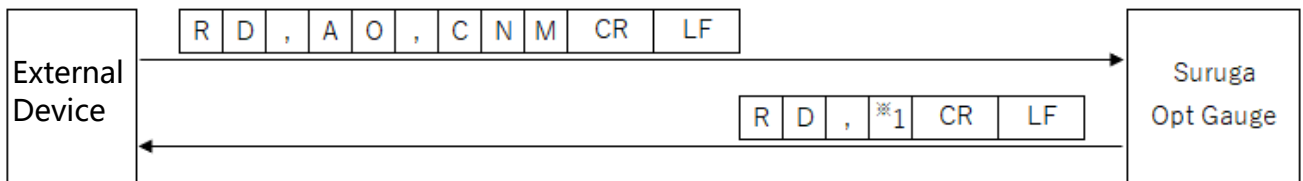

*1: Beam Centroid ("0" = area, "1" = intensity)

[Read Angle Unit setting information]

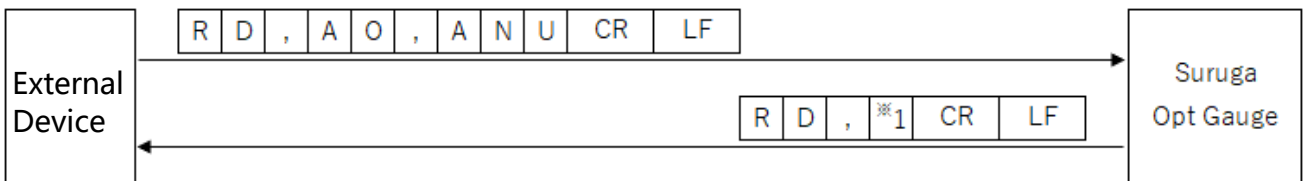

*1: Angle Unit ("0" = degree, "1" = DegMinSec, "2" = milliradian)

[Read Denoising enabled setting information]

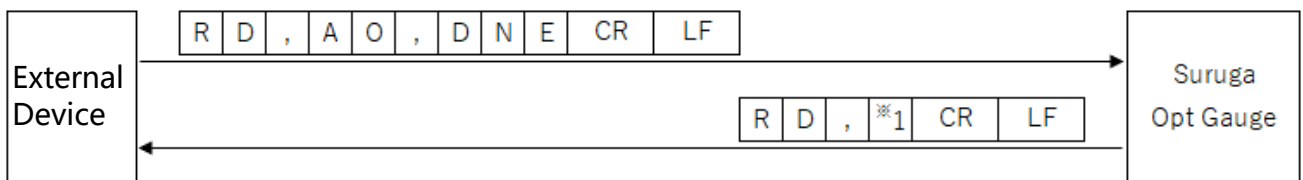

*1: Denoising function ("0" = disabled, "1" = enabled)

[Read Denoising Threshold value setting information]

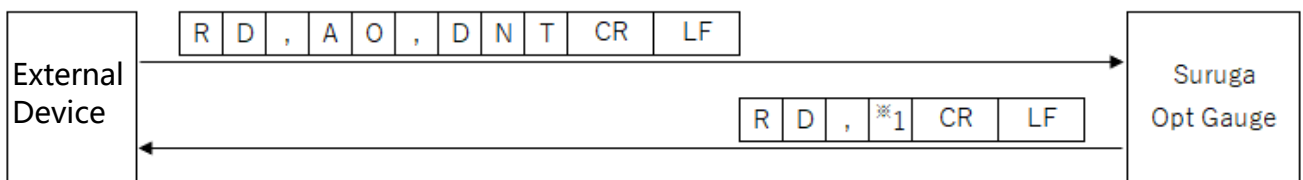

*1: Denoising threshold value (1 to 4,095)

[Read Angle X decimal place setting information]

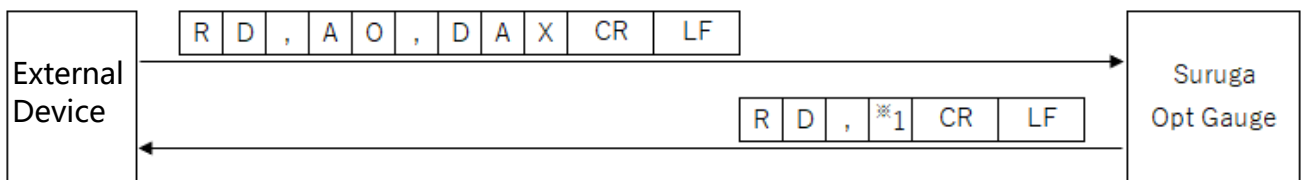

*1: Angle X decimal place (0 to 8)

[Read Angle Y decimal place setting information]

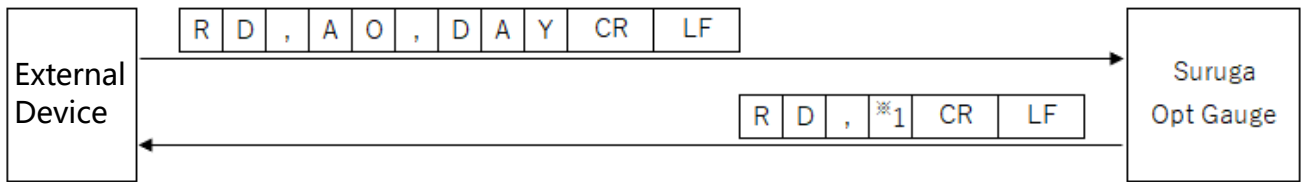

*1: Angle Y decimal place (0 to 8)

[Read Angle D decimal place setting information]

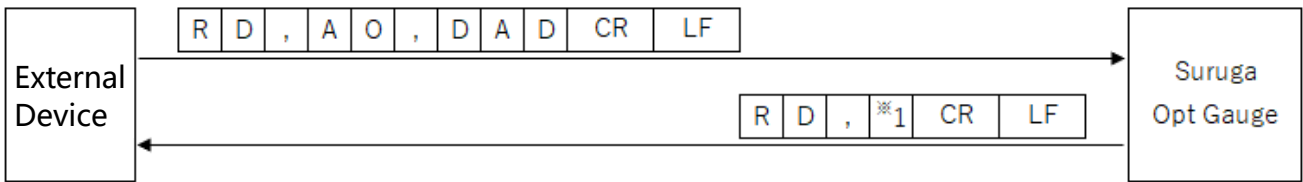

*1: Angle D decimal place (0 to 8)

[(Beam Divergence) Read D4Sigma decimal place setting information]

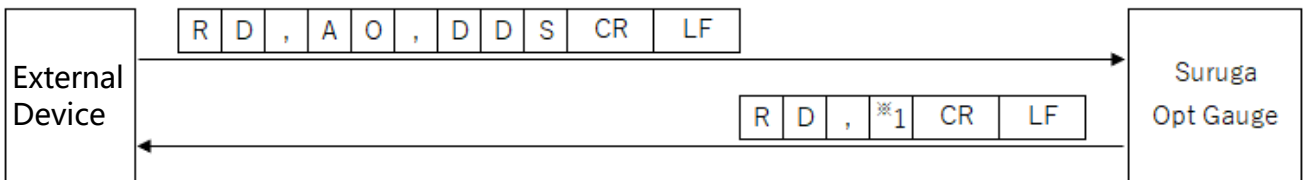

*1: D4Sigma decimal place (0 to 8)

[(Beam Divergence) Read D4Sigma X(M) decimal place setting information]

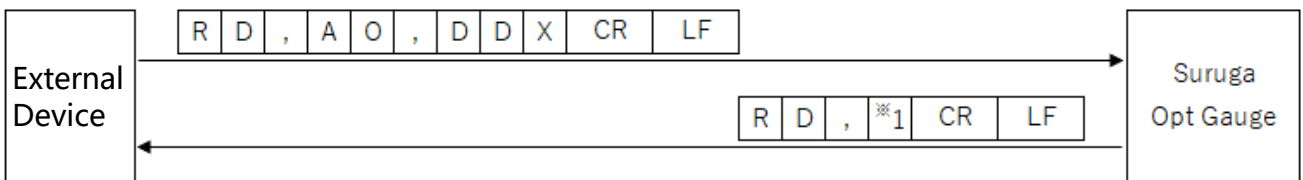

*1: D4Sigma X(M) decimal place (0 to 8)

[(Beam Divergence) Read D4Sigma Y(m) decimal place setting information]

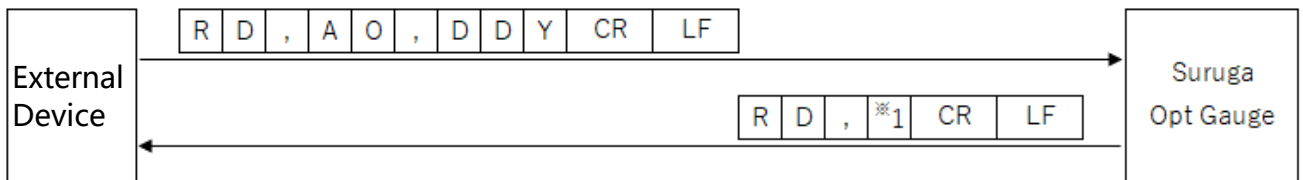

*1: D4Sigma Y(m) decimal place (0 to 8)

[(Beam Divergence) Read D86 decimal place setting information]

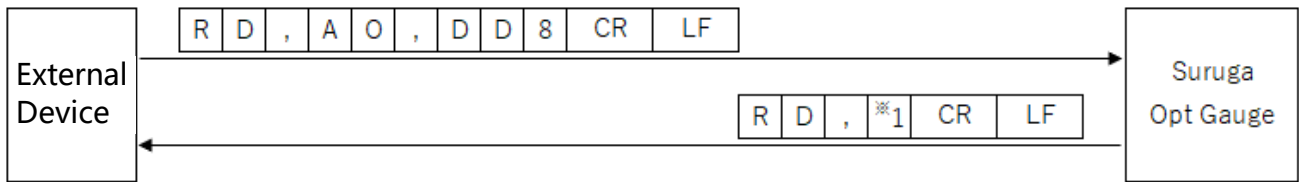

*1: D86 decimal place (0 to 8)

[Read Ellipticity decimal place setting information]

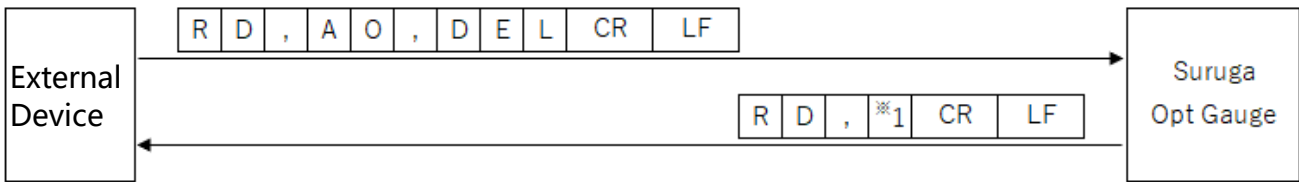

*1: Ellipticity decimal place (0 to 8)

[(Multi Spot) Read Order setting information]

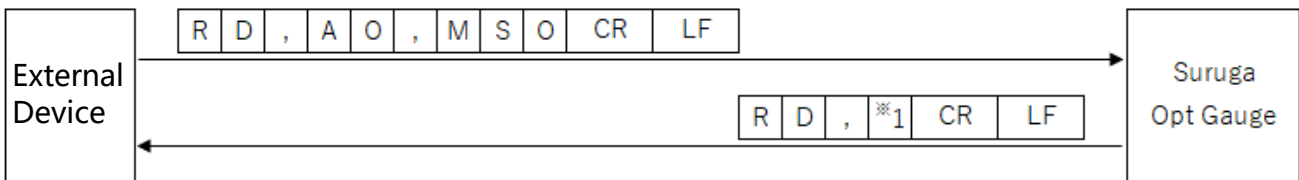

*1: (Multi Spot) List sort type ("0" = area, "1" = angle)

[(Multi Spot) Read Spot Count setting information]

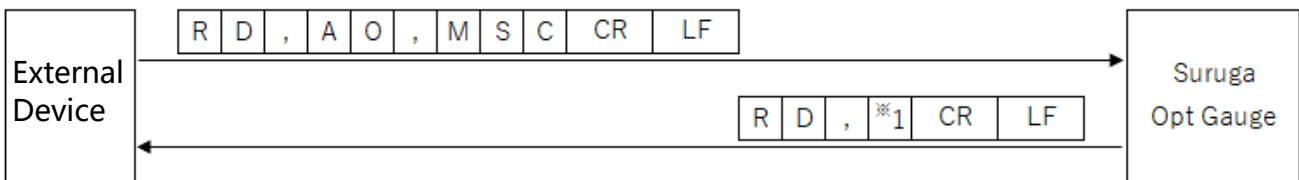

*1: Spot count (1 to 100)

[(Multi Spot) Read Minimum Spot Area setting information]

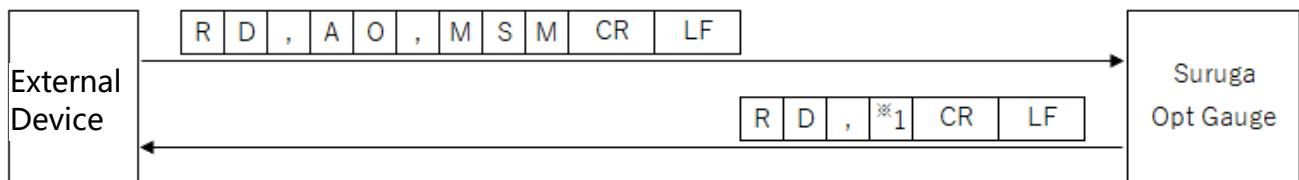

*1: Minimum spot area (1 to 1023)

[Read Adaptive Cal Execution button display enabled setting information]

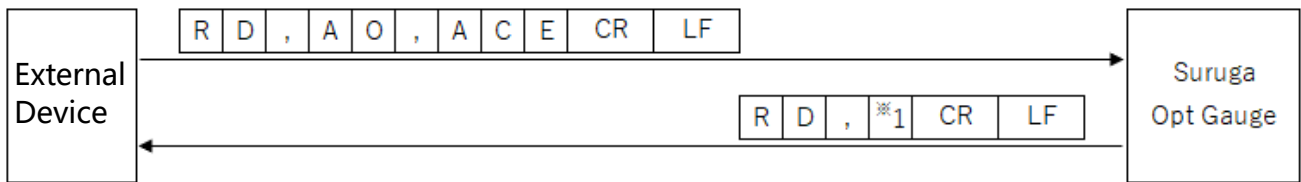

*1: Adaptive Cal execute button display ("0" = disabled, "1" = enabled)

[Read Orientation Enabled setting information]

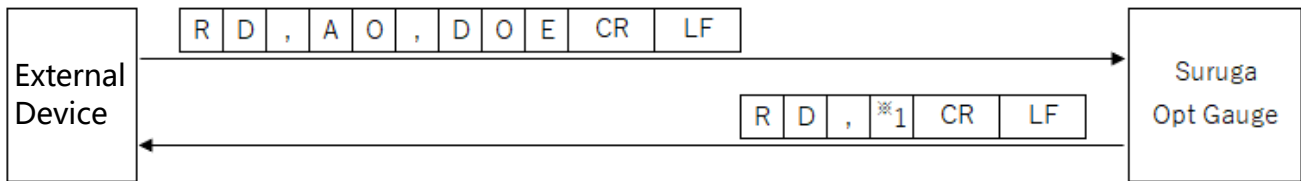

*1: Orientation Enabled ("0" = disabled, "1" = enabled)

[Read Binning Enabled setting information]

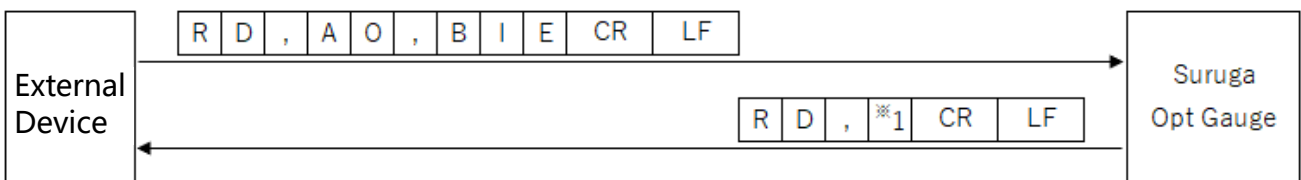

*1: Binning setting ("0" = disabled, "1" = enabled)

[Read Working Distance setting information]

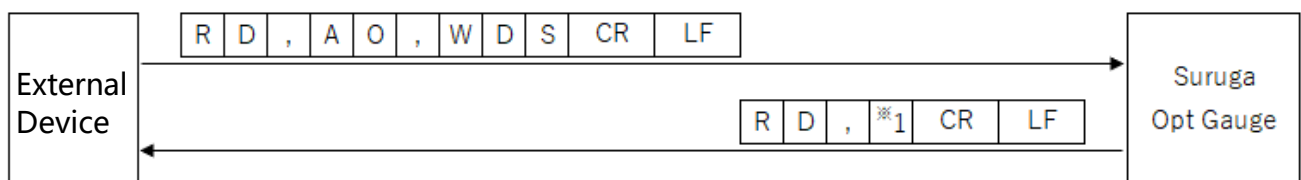

*1: Working Distance setting value (30 to 300)

[Read Display Spot Number setting information]

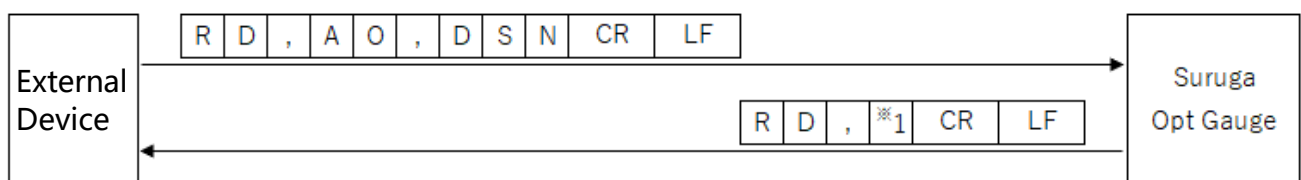

*1: Display Spot Number (0 to 100)

5.5. Write Commands

5.5.1. Command Format

[Write sensor camera Exposure Time]

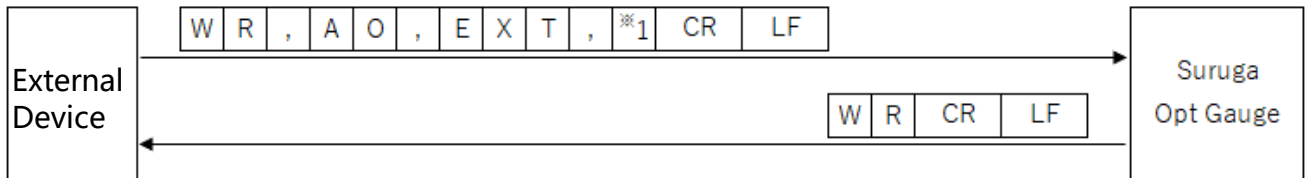

*1: Exposure time (0.027 to 2000)

[Write sensor camera Frame Rate]

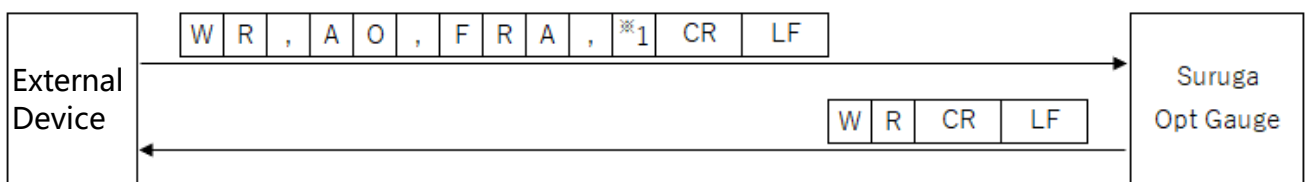

*1: Frame Rate (0.1 to 100)

[Write Rotation setting information]

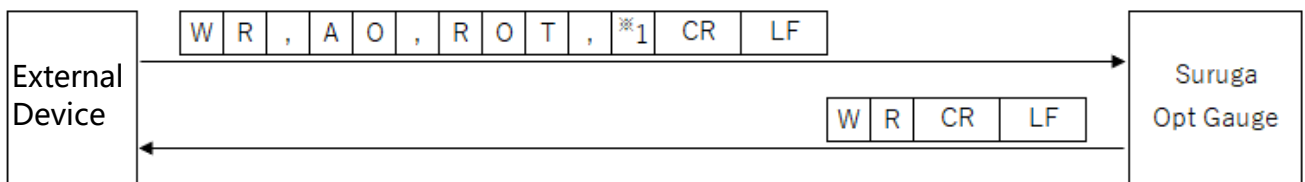

*1: Rotation ("0" = OFF, "1" = Rotation right 90°, "2" = Rotation right 180°, "3" = Rotation right 270°)

[Write Mirroring Horizontal setting information]

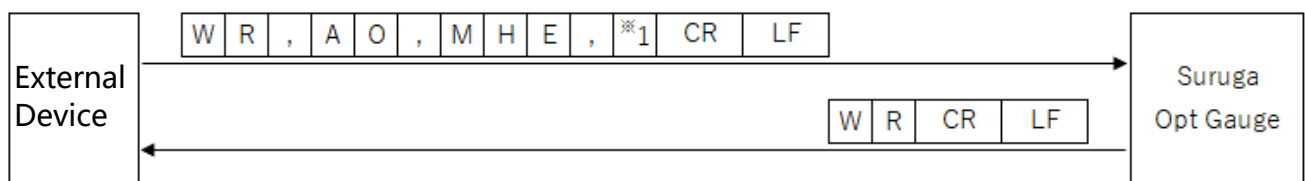

*1: Mirroring ("0" = OFF, "1" = horizontal mirroring)

[Write Mirroring Vertical setting information]

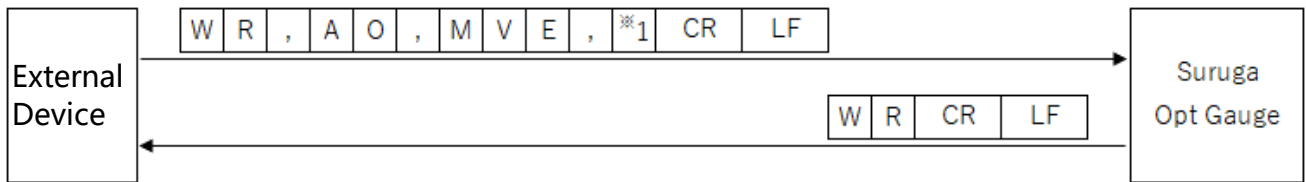

*1: Mirroring ("0" = OFF, "1" = vertical mirroring)

[Write Number of Averaging Times setting information]

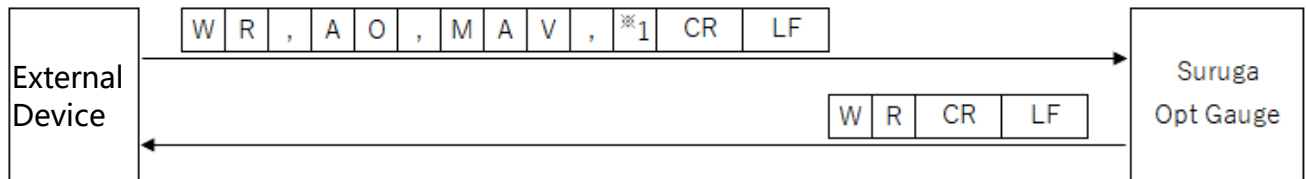

*1: Number of Averaging Times (2 to 262,144)

[Write Averaging Processing enabled setting information]

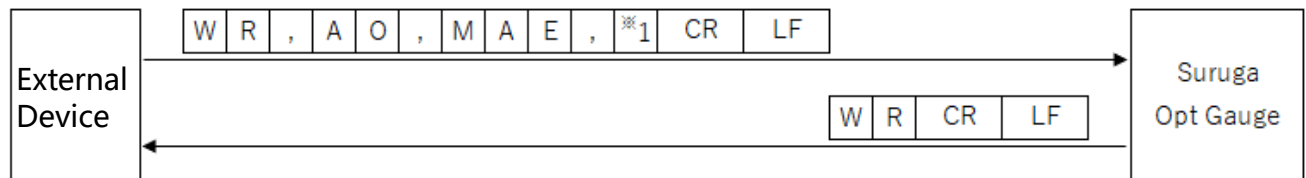

*1: Averaging Processing ("0" = disabled, "1" = enabled)

[Write Cross Section Point setting information]

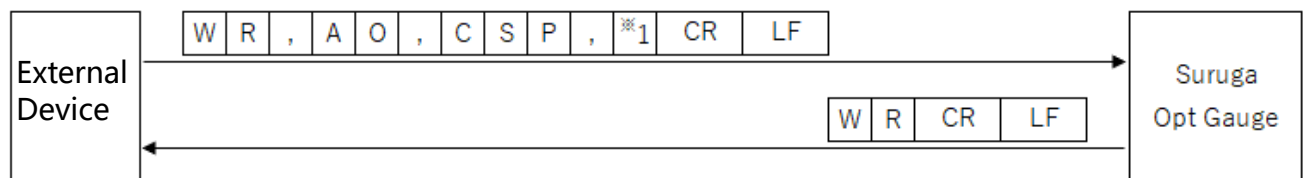

*1: Cross Section Point ("0" = Origin Cursor, "1" = Beam Cursor)

[Write OriginOffset X value setting information]

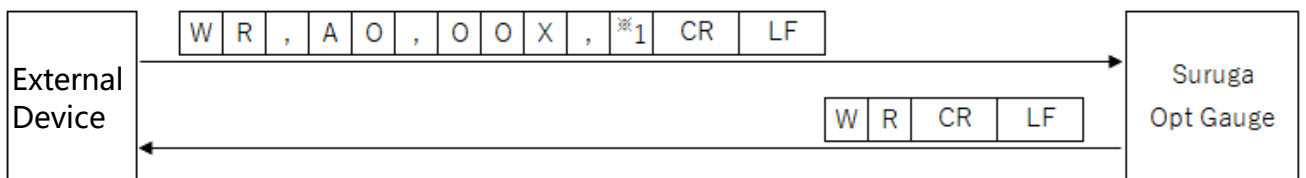

*1: OriginOffset X (-20 to 20)

[Write OriginOffset Y value setting information]

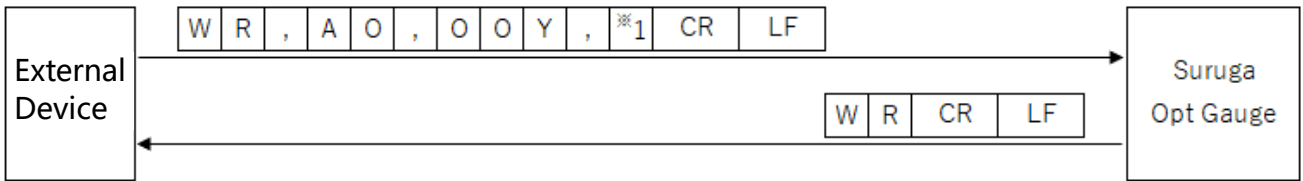

*1: OriginOffset Y (-20 to 20)

[Write Auto Aperture Method setting information]

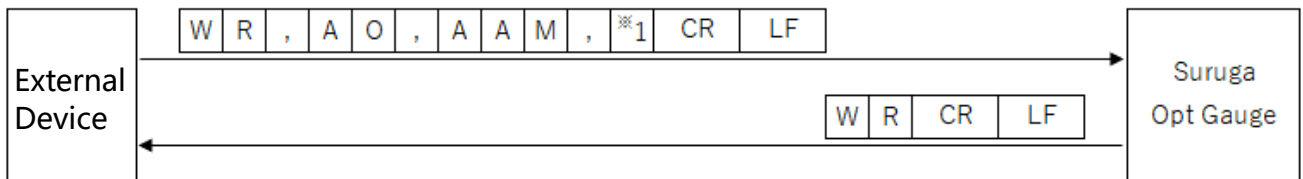

*1: Auto Aperture Method ("0" = area, "1" = luminance)

[Write Auto Aperture enabled setting information]

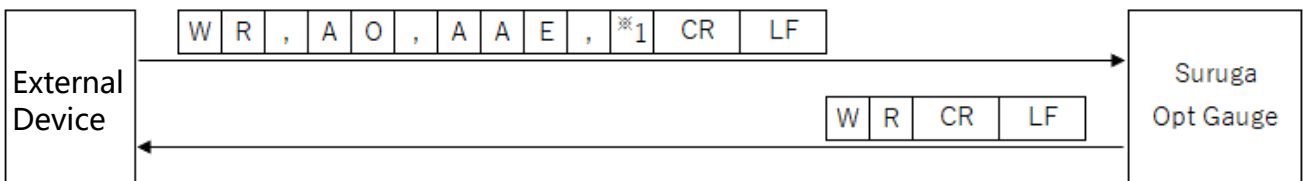

*1: Auto Aperture ("0" = disabled, "1" = enabled)

[Write ROI enabled setting information]

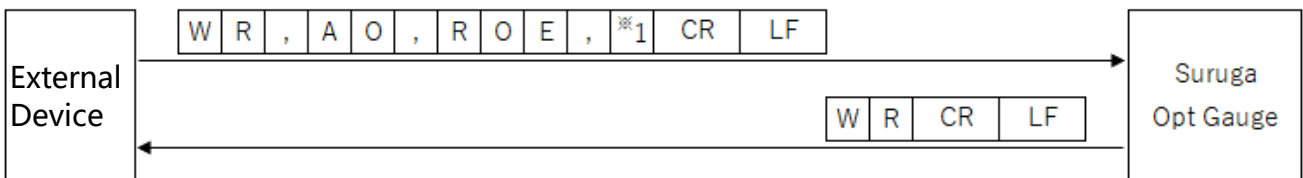

*1: ROI ("0" = disabled, "1" = enabled)

[Write ROI X value setting information]

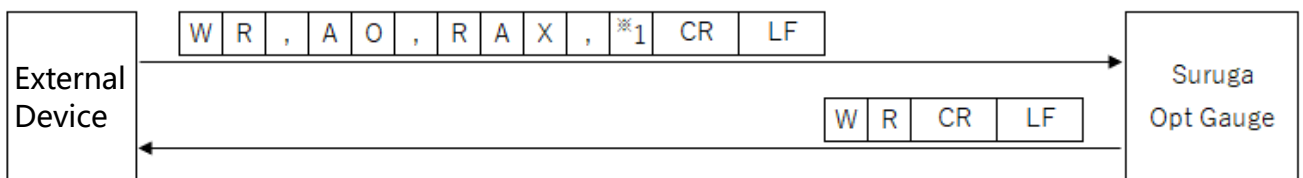

*1: ROI X value (-3,000 to 3,000)

[Write ROI Y value setting information]

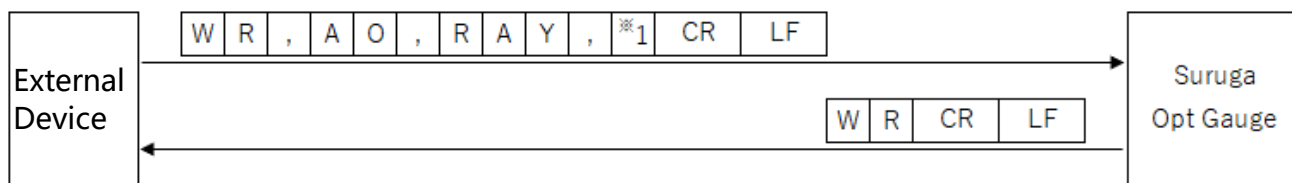

*1: ROI Y value (-3,000 to +3,000)

[Write ROI Width setting information]

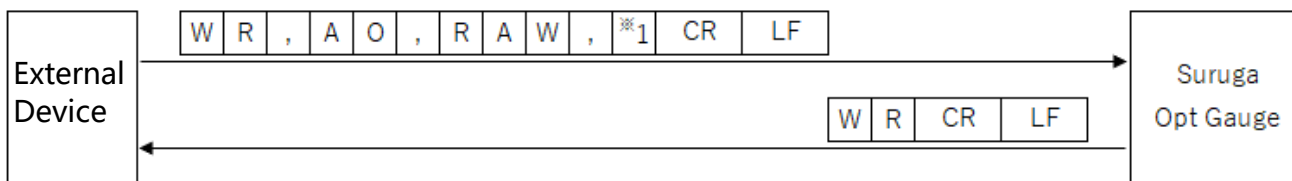

*1: ROI Width (0 to 3,000)

[Write ROI Height setting information]

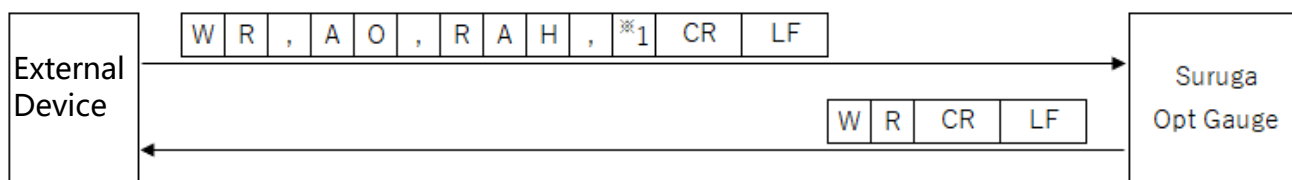

*1 : ROI Height (0~3,000)

[Write Angle Type setting information]

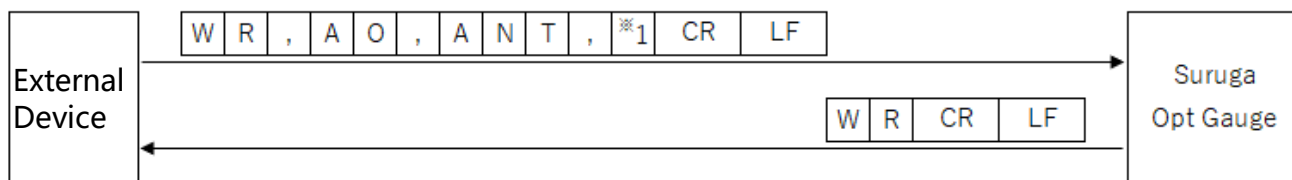

*1: Angle Type ("0" = tilt angle, "1" = beam angle)

[Write Judgement Angle Enabled setting information]

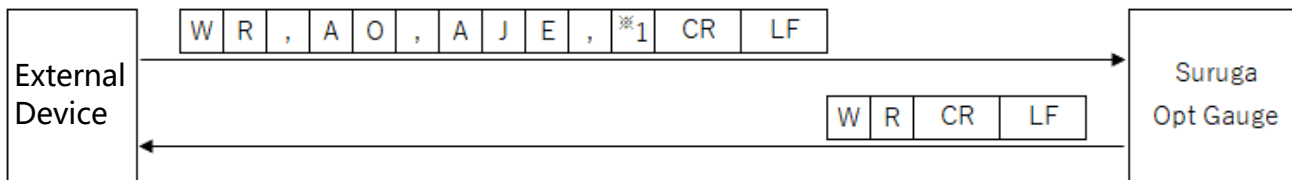

*1: Judgement Angle ("0" = disabled, "1" = enabled)

[Write judgement value setting information at the Judgement Angle]

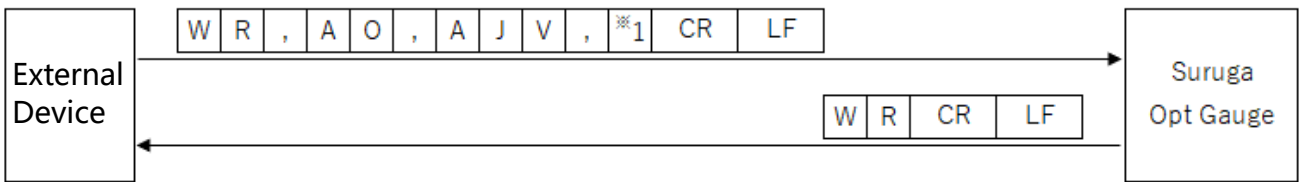

*1: judgement value (0 to 20) at the Judgement Angle

[Write Judgement Divergence Enabled setting information]

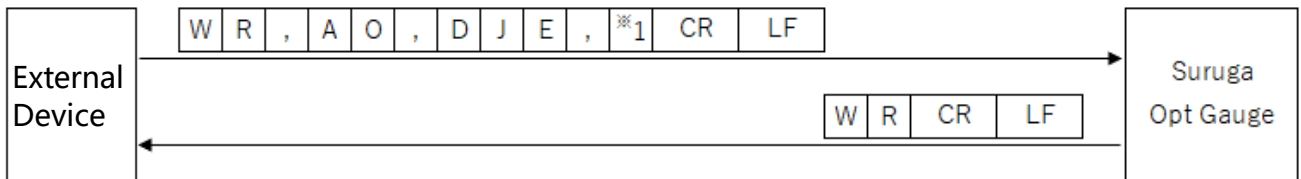

*1: Judgement Divergence ("0" = disabled, "1" = enabled)

[Write judgement value setting information at Judgement Divergence]

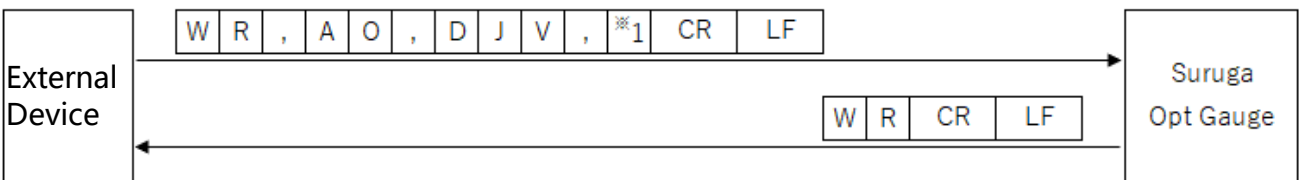

*1: judgement value (0.0000 to 1,000.0000) at the Judgement Divergence

[Write Judgement RadiusType setting information]

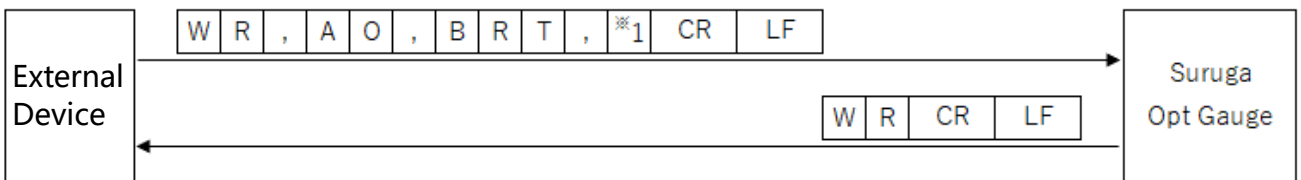

*1: Judgement RadiusType ("0" = D4Sigma, "1" = D86)

[Write Judgement Ellipticity enabled setting information]

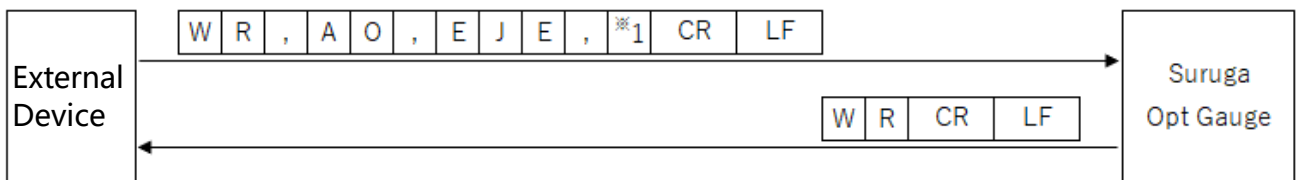

*1: Judgement Ellipticity ("0" = disabled, "1" = enabled)

[Write judgement value setting information at the Judgement Ellipticity]

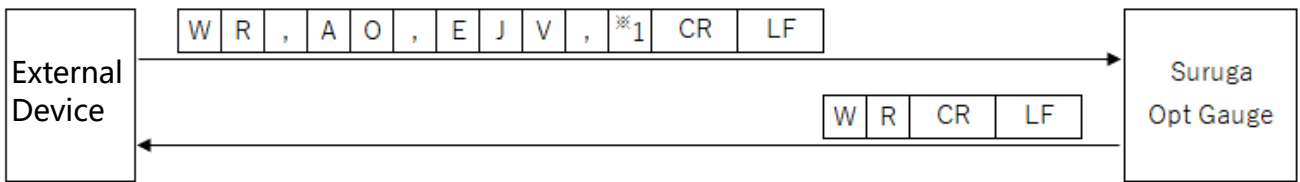

*1: Judgement Ellipticity judgement value (0.0000 to 1.0000)

[Write Judgement Peak Enabled setting information]

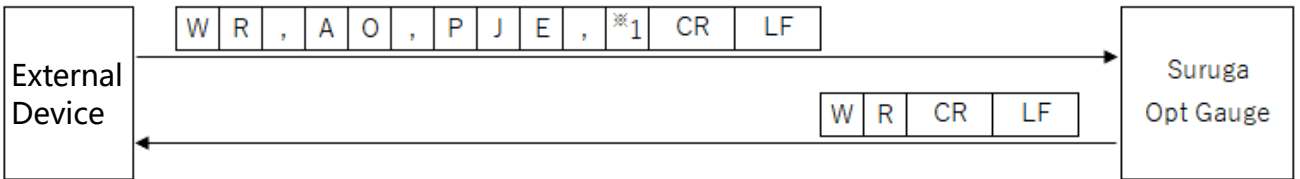

*1: Judgement Peak ("0" = disabled, "1" = enabled)

[Write judgement value setting information at the Judgement Peak]

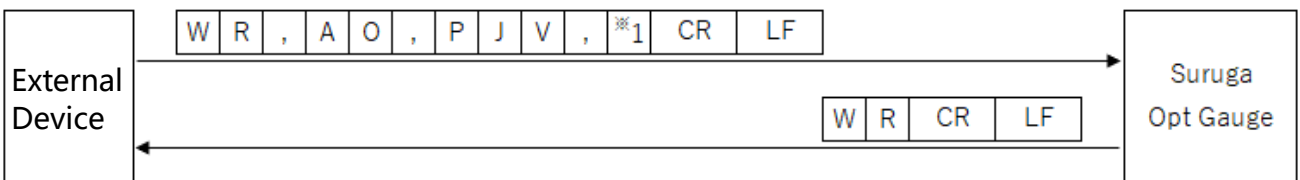

*1: judgement value (0.0 to 4,095.0) at the Judgement Peak

[Write Beam Centroid setting information]

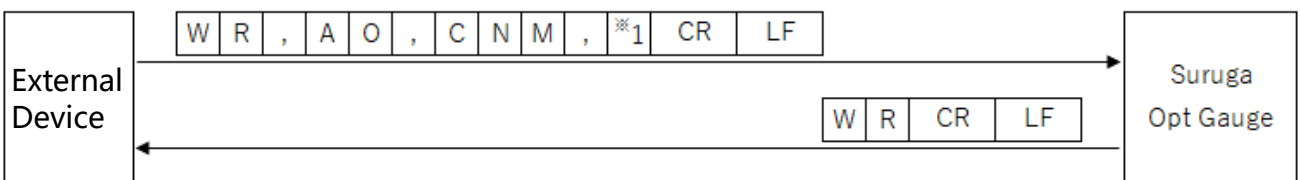

*1: Beam Centroid ("0" = area, "1" = Intensity)

[Write Angle Unit setting information]

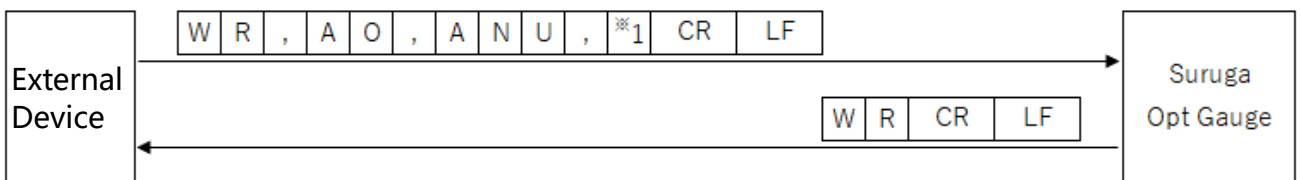

*1: Angle Unit ("0" = degree, "1" = DegMinSec, "2" = milliradian)

[Write Denoising Enabled setting information]

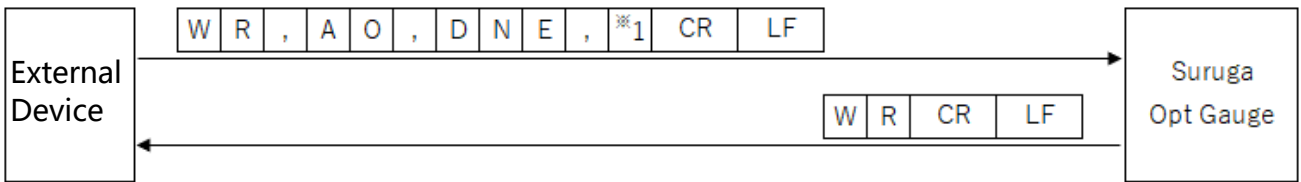

*1: Denoising function ("0" = disabled, "1" = enabled)

[Write Denoising Threshold value setting information]

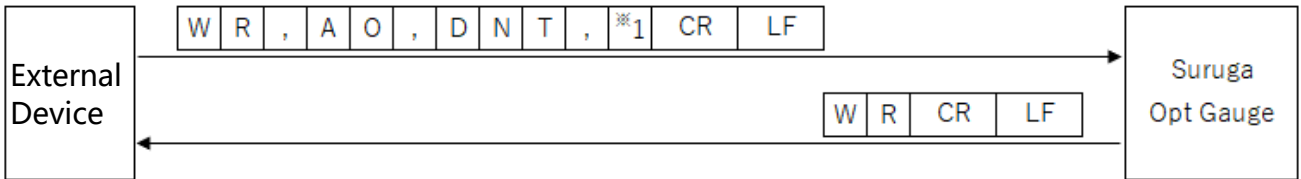

*1: Denoising threshold value (1 to 4,095)

[Write Angle X decimal place setting information]

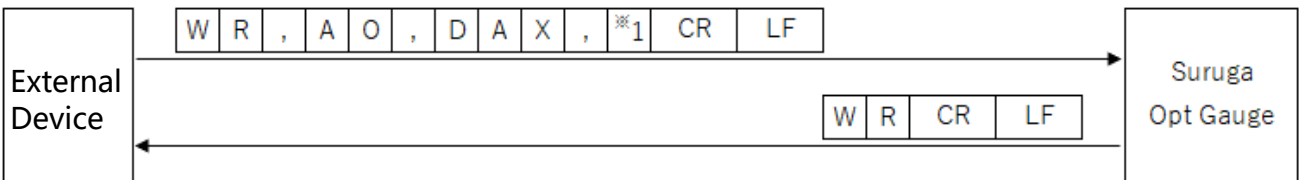

*1: Angle X decimal place (0 to 8)

[Write Angle Y decimal place setting information]

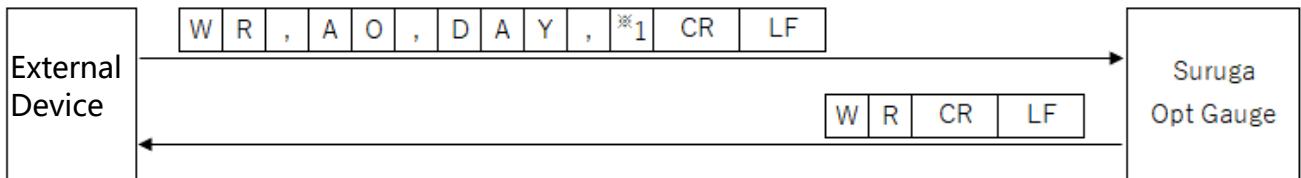

*1: Angle Y decimal place (0 to 8)

[Write Angle D decimal place setting information]

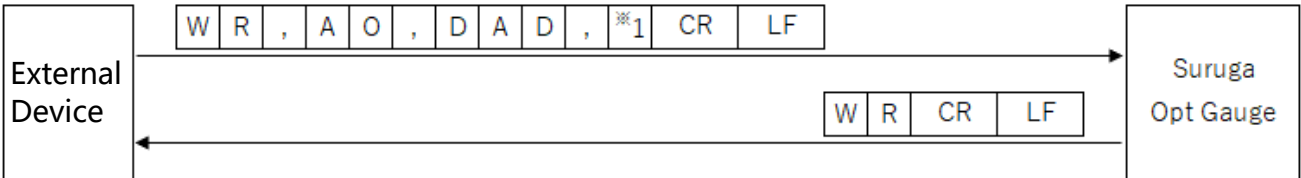

*1: Angle D decimal place (0 to 8)

[(Beam divergence) Write D4Sigma decimal place setting information]

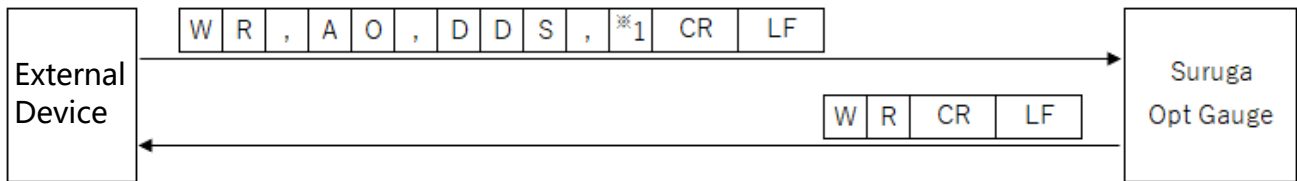

*1: D4Sigma decimal place (0 to 8)

[(Beam divergence) Write D4Sigma X(M) decimal place setting information]

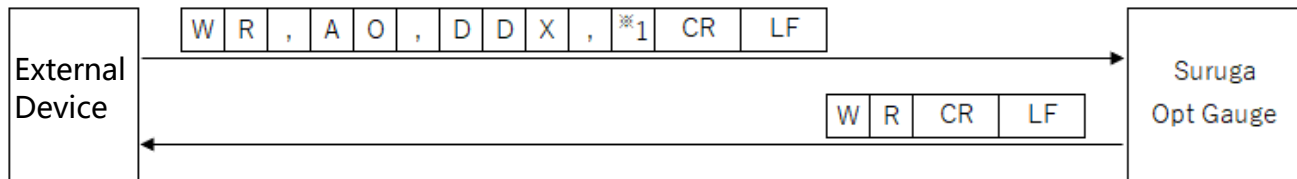

*1: D4Sigma X(M) decimal place (0 to 8)

[(Beam divergence) Write D4Sigma Y(m) decimal place setting information]

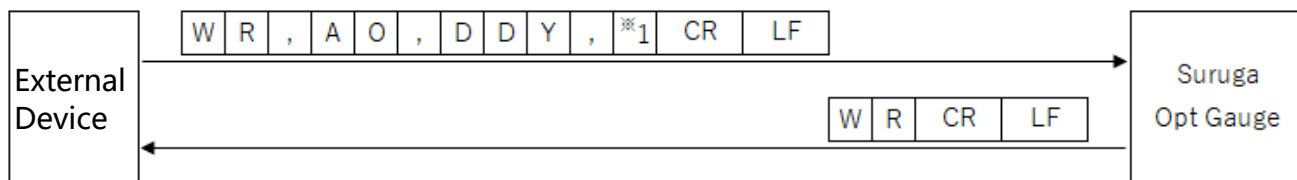

*1: D4Sigma Y(m) decimal place (0 to 8)

[(Beam divergence) Write D86 decimal place setting information]

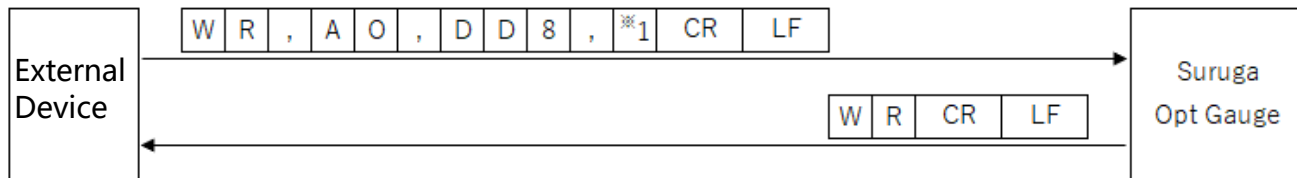

*1: D86 decimal place (0 to 8)

[Write Ellipticity decimal place setting information]

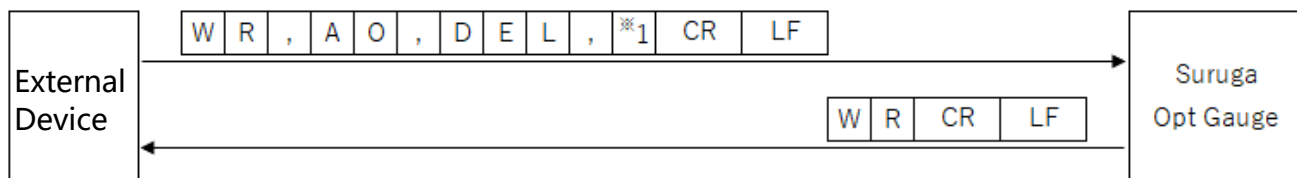

*1: Ellipticity decimal place (0 to 8)

[(Multi Spot) Write Order setting information]

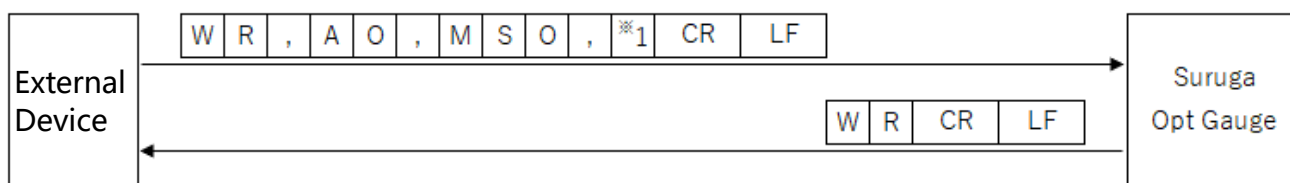

*1: (Multi Spot) list sort type ("0" = Area, "1" = Angle)

[(Multi Spot) Write Spot Count setting information]

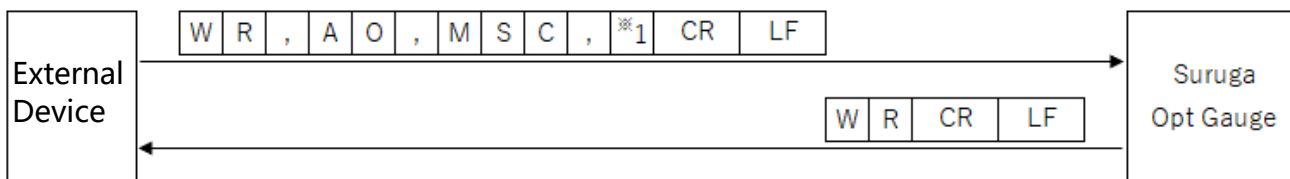

*1: Spot Count (1 to 100)

[(Multi Spot) Write Minimum Spot Area setting information]

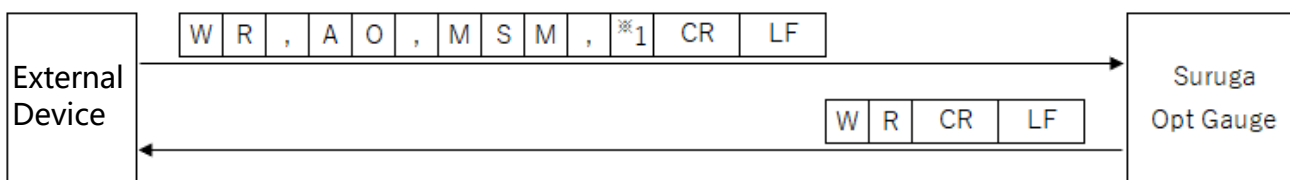

*1: Minimum Spot Area (1 to 1023)

[Write Adaptive Cal Execution button display enabled setting information]

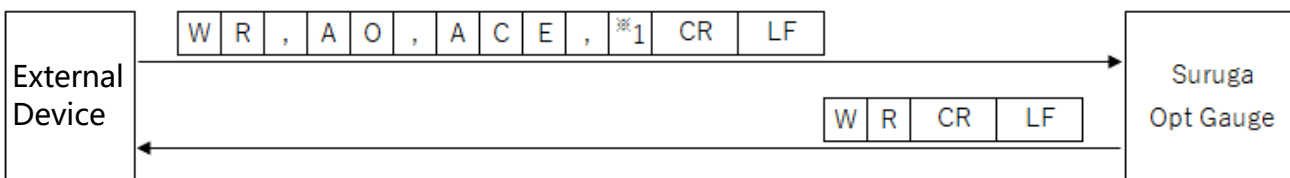

*1: Adaptive Cal execution button display ("0" = disabled, "1" = enabled)

[Write Orientation Enabled setting information]

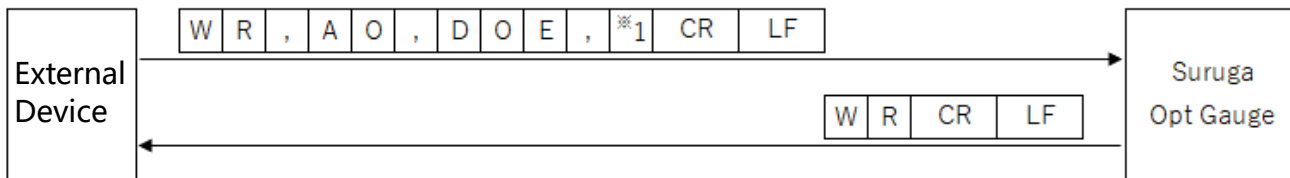

*1: Orientation Enabled ("0" = disabled, "1" = enabled)

[Write Binning Enabled setting information]

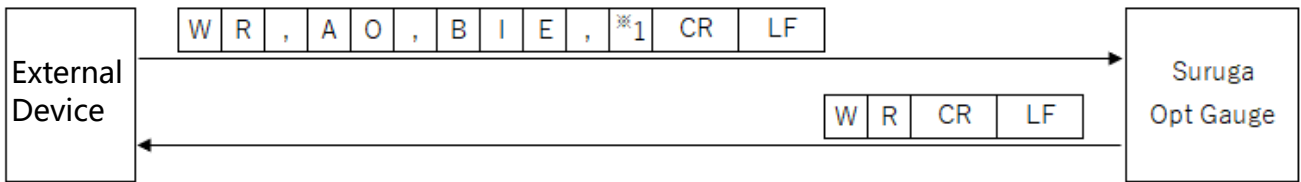

*1: Binning setting ("0" = disabled, "1" = enabled)

[Write Working Distance setting information]

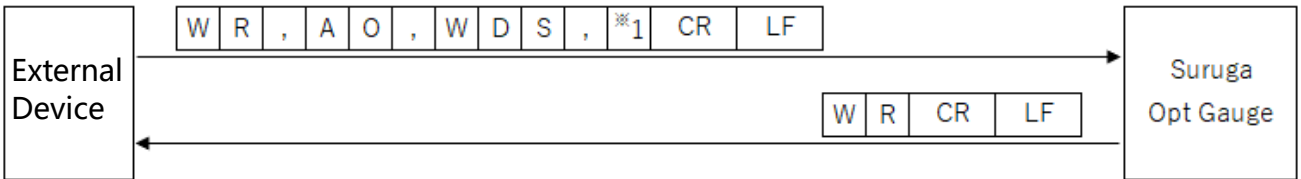

*1: Working Distance setting value (30 to 300)

[Write Display Spot Number setting information]

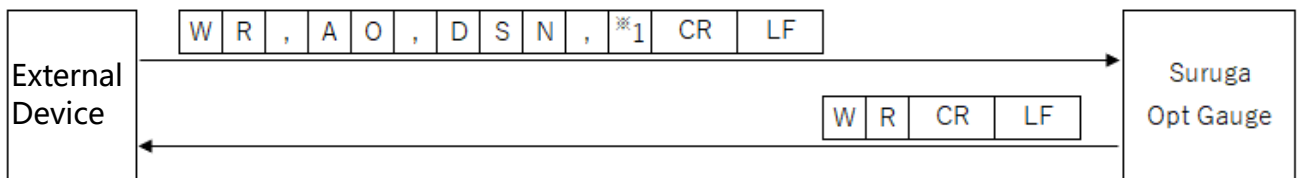

*1: Display Spot Number setting value (0 to 100)

5.6. Execute Commands

5.6.1. Command Format

[Option save]

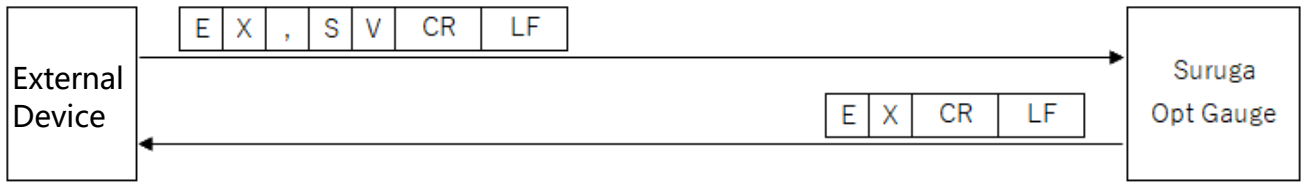

5.7. Communication error

When a command was not successfully received or could not be executed, the Products will return error information in the following format.

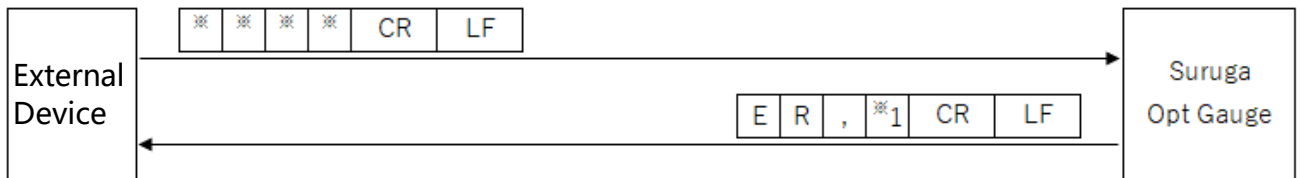

The error codes appear in ^1 as below.

"2": Setting Data Error

- Value outside setting range was set.

"3": Command Format Error

- Number of commas from header to [CRLF] does not match.
- Command not in command list, or non-alphanumeric characters.
- Text after header includes characters not in list above.

"5": Condition Error

- Value outside setting range was set.

6. System Log

6.1. System Log List

System Log	Content
Angle view initialize succeeded.	Angle screen initialization was successful. Measurement starts normally.
Angle view initialize failed. Please check the connection with Suruga OptGauge.	Angle screen initialization failed. Check the sensor head and computer connection.
Angle result output succeeded.	Measurement results output with [Output Once] button was successful.
Angle result output failed.	Measurement results output with [Output Once] button failed.
Adaptive Cal succeeded.	Adaptive calibration with [Adaptive Cal] button was successful.
Adaptive Cal failed.	Adaptive Cal with [Adaptive Cal] button failed.
It is necessary to block the light.	Adaptive Cal failure: Block the light.

6.2. Error Messages and Countermeasures

Error message	Cause	Countermeasure
Angle view initialize failed. Please check the connection with Suruga OptGauge.	Sensor head and computer are not connected.	<p>Check that sensor head and computer are connected and restart OptGauge.</p> <p>If this error is repeatedly generated, the sensor head interior camera may not be working properly.</p> <p>Contact the Suruga Seiki Optical Device Business Division Sales Section.</p>
Angle result output failed.	Measurement results output file (.csv) is open. Output destination file path or file cannot be found.	<p>Please close the measurement results output file (.csv) if opened and execute outputting measurement results.</p> <p>Check that the output destination file path or file exists.</p>
Adaptive Cal failed. It is necessary to block the light.	Because the light is not blocked, the Adaptive Cal cannot be executed.	<p>Check that the beam is not incoming to the sensor head.</p> <p>Also, make sure before measurement that there is no unwanted exterior light or other laser light source interfering with the sensor.</p>

7. Specifications for H420 Series Sensor Head and Accessories

7.1. Sensor Head Specifications

Item		Specifications	
Light Source	Wavelength	405 nm or 660 nm	
	Emitted light Intensity	405 nm	660 nm
		< 0.39 mW	< 1 mW
	Emission Position	12 mm × 20 mm (distance from the reference plane) (see "H420 Series External Dimensions")	
Angle Measurement	Range	±1.35°: Measurement distance < W.D. = 0 to 150 (mm)	
		±1.00°: Measurement distance < W.D. = 150 to 200 (mm)	
		±0.75°: Measurement distance < W.D. = 200 to 250 (mm)	
±0.50°: Measurement distance < W.D. = 250 to 300 (mm)			
		At measuring reflection angles	
Repeatability		1s (6σ)*1	
Linearity (Ave.)		+/- 0.25% of F.S. (F.S. = 2.7°) *2	
Divergence	Range	≤ 20 mrad	
	Linearity	5% of F.S. (F.S. = 20 mrad)	
Beam Diameter		Collimated light specification (Model: H-420-CL)	
		0.5 mm (only 405 nm), 1.0 mm and 3.0 mm *3	
Frame Rate		15 Hz @recommended PC Spec.	
Environment Conditions	Operating Environment *4	0 to +40 °C and 35 to 85% RH	
	Storing Environment	-10 to +60 °C	
	Vibration Resistance	Frequency range: 10 Hz to 500 Hz Maximum acceleration: 2 G in X,Y,Z 3 directions @10 sweeps	
Weight		0.4 kg	

*1 When measuring with number of averaging of 256 times

*2 When measuring at W.D. of 100 mm

*3 When measuring at W.D. of 300 mm

*4 Factory Inspection Environment: 22 to 24 °C, 35 to 85% RH

7.2. AC/DC Converter Electrical Specifications

AC adapter Specifications Overview	
Rated Input (AC)	100 V to 240 V
Rated Output (DC)	12 V / 3.0 A
Acquired Industrial Standards	PSE, BSMI, cUL, FCC, KC, CE, GS, RCM, CCC
Protective Functions	Short-circuit protection, overcurrent protection, overvoltage protection
RoHS	RoHS10
AC Side Plug Shape	Type-A
Product Dimensions (mm)	99 x 50 x 33
DC Cable Length	1.5 m ±30 mm
DC Plug Polarity	Center Positive

7.3. Sensor Head and Cable Electrical Specifications

Sensor head and cable specifications overview	
Rated input (power consumption)	12 VDC / 3 A (5 W or below)
Cable Type	USB cable compliant with USB3.0 (5Gbps) standard
Connector	USB3.0 Type A
Cable Length	3.0 m

8. Failures? Frequently Asked Questions

Symptom and Countermeasures

Useful information for troubleshooting is listed below.

Check if the table below shows your trouble.

Symptom	Cause	Countermeasure
Internal light source power is NOT turned on.	AC adapter or power cable is not correctly connected.	DC12V is not supplied.
	DC12V is not supplied.	Correctly connect the DC12V power source.
Application does not start.	USB cable is not correctly connected.	Connect the USB cable to the USB3.0 port.
	Device authentication file is not being read.	Read the device authentication file (.suruga) corresponding to the purchased sensor head.
Application stops during startup	USB cable disconnected.	Close the application, connect the USB cable correctly, and restart the application.
Beam is not displayed on screen	Exposure Time is too short.	Adjust the Exposure Time to the optimal speed.
	Large tilt on the target.	Adjust the tilt angle of the target so that the reflected light beam enters within a viewing range of $\pm 1.35^\circ$.
Measurement target centroid is unstable	Noise is causing serious effects	Enable the Threshold in the Denoising settings and adjust the threshold.
RS232C communication is not working	RS232C cable is not correctly connected	Correctly connect RS232C cable.
	Computer communication conditions are not set correctly.	Set the communication settings correctly at the PC.
TCP/IP communication is not working	Ethernet cable is not correctly connected.	Correctly connect the Ethernet cable.
	Computer communication conditions are not met correctly.	Set the communication settings correctly at the PC.

9 Warranty - After-Sales Service

9.1 Warranty Terms, Conditions and Coverage

- Before contacting us, please confirm the serial number of the individual product.
- The warranty period is one year after delivery.
- However, the following cases are not covered by the warranty and will be repaired for a fee.
 - Failure or damage caused by misuse, modification or repair by someone other than the company' s designated persons from us.
 - Failure or damage caused by improper handling, such as dropping the Products during transportation or moving.
 - Failure or damage caused by fire, salt damage, gas damage, abnormal voltage, earthquake, lightning, wind, flood, or other natural disasters
 - In the event of a malfunction or damage caused by improper handling contrary to the methods and precautions described in the instruction manual.

We reserve the right to revise, modify, or amend these Warranty Terms and Conditions (hereinafter referred to as "Revisions, etc."), and in the event of such revisions, etc., we shall promptly post the revised Warranty Terms and Conditions in this catalog or on our website (<http://jpn.surugaseiki.com/>). If you place an order for the Products after such revision, you shall be deemed to have accepted the revision.

9.2 After-Sales Service

Before requesting repair, please check the items in "8. Frequently Asked Questions".If you have any questions, please contact our Optical Instruments Division Sales Department.

<During the Warranty Period>

When damage occurs under a normal use state following the cautions/warnings/notes written in this manual, Suruga conducts a repair service for free. For any damages out of warranty period mentioned above, Suruga charges a fee for any repair service.

<After the Warranty Period>

A repair service is available with a fee to maintain the functionalities of the Products up on your requests.

SURUGA SEIKI CO., LTD.

HEAD OFFICE

505, Nanatsushinya, Shimizu-ku,
Shizuoka City, Shizuoka 424-8566, Japan
Tel : +81-54-344-0332 Fax : +81-54-346-1196
<https://eng.surugaseki.com/>